

# CPTC Thermistor : TPM-P Type

## SMD CPTC Thermistor for Over-Current Protection



### ■ Features

1. RoHS & Halogen-free compliant
2. EIA size 0603,0805,1210
3. Suitable for reflow soldering
4. Suitable for over-current or short circuit protection
5. Agency Recognition:  
UL&cUL:File No.E138827  
TUV:File No.R50193877



### ■ Recommended Applications

1. Notebook computer
2. AC adapter
3. Battery charger
4. LED
5. Over-current protection for any consumer device

### ■ Part Number Code

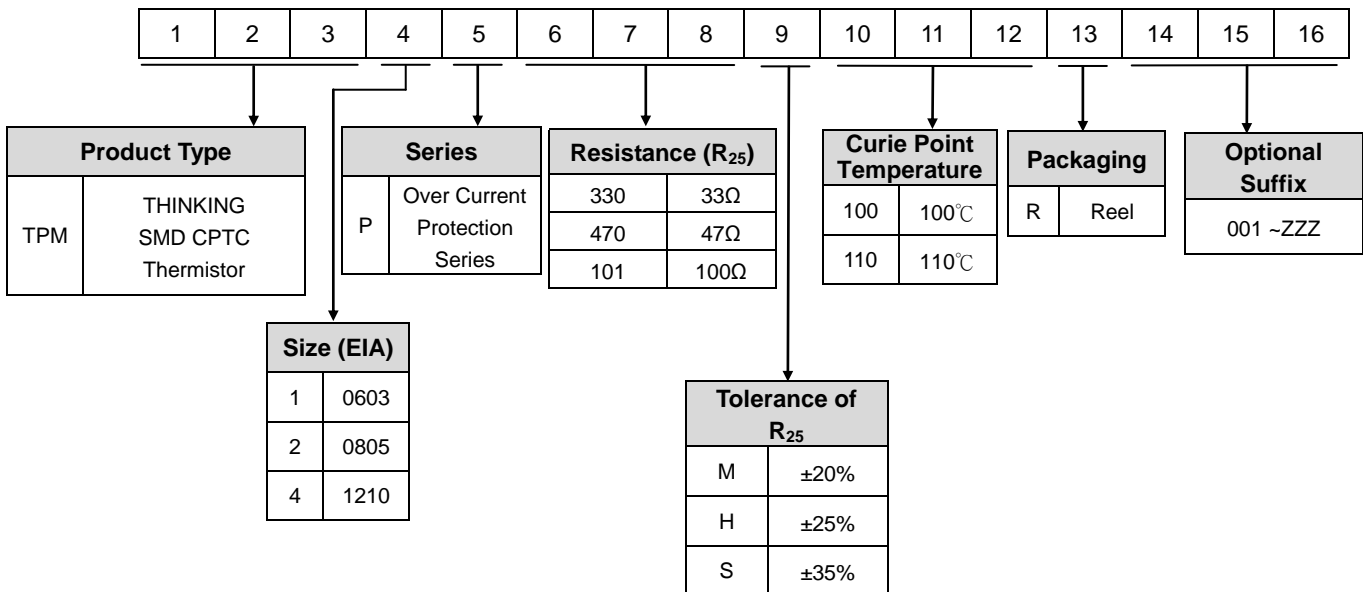

### ■ Structures and Dimensions

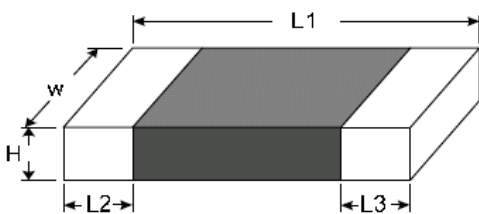

(Unit: mm)

Part No.	Size (EIA)	L1	W	H max.	L2 and L3.
TPM1P	0603	1.60±0.15	0.80±0.15	0.95	0.40±0.20
TPM2P	0805	2.00±0.20	1.25±0.20	1.00	0.45±0.25
TPM4P	1210	3.20±0.30	2.50±0.25	1.80	0.50±0.20
For TPM2P150M100R & TPM2P220M100R					
TPM2P	0805	2.00±0.20	1.25±0.20	1.45	0.45±0.25

# CPTC Thermistor : TPM-P Type

## SMD CPTC Thermistor for Over-Current Protection



### Electrical Characteristics

#### SMD 0603

Part No.	Curie Point Temp.	Zero Power Resistance at 25°C	Non-operating Current		Trip Current		Max. Voltage	Max. Current	Operating Temperature Range		Safety Approvals	
			@ +60°C	@ +25°C	@+25°C	@ -10°C			@ Vmax	@V=0	UL/cUL	TUV
	Tc (°C)	R <sub>25</sub> (Ω)	I <sub>n</sub> (mA)		I <sub>t</sub> (mA)		V <sub>max</sub> (V <sub>DC</sub> )	I <sub>max</sub> (mA)	T <sub>L</sub> ~T <sub>U</sub> (°C)		UL/cUL	TUV
TPM1P330M100R	100±10	33	25	36	71	85	24	900	-10 ~ +60	-40 ~ +125	√	√
TPM1P470M100R		47	20	29	61	75		630			√	√
TPM1P101M100R		100	15	21	45	55		300			√	√
TPM1P221M100R		220	10	14	29	35		130			√	√
TPM1P471M100R		470	7	10	21	25		60			√	√

#### SMD 0805

Part No.	Curie Point Temp.	Zero Power Resistance at 25°C	Non-operating Current		Trip Current		Max. Voltage	Max. Current	Operating Temperature Range		Safety Approvals	
			@ +60°C	@ +25°C	@+25°C	@ -10°C			@ Vmax	@V=0	UL/cUL	TUV
	Tc (°C)	R <sub>25</sub> (Ω)	I <sub>n</sub> (mA)		I <sub>t</sub> (mA)		V <sub>max</sub> (V <sub>DC</sub> )	I <sub>max</sub> (mA)	T <sub>L</sub> ~T <sub>U</sub> (°C)		UL/cUL	TUV
TPM2P150M100R	100±10	15	40	59	116	140	20	1600	-10 ~ +60	-40 ~ +125		
TPM2P220M100R		22	30	44	91	110		1100				
TPM2P221M100R		220	10	14	29	35	24	130				

#### SMD 1210

Part No.	Curie Point Temp.	Zero Power Resistance at 25°C	Non-operating Current		Trip Current		Max. Voltage	Max. Current	Operating Temperature Range		Safety Approvals	
			@ +85°C	@ +25°C	@+25°C	@ -40°C			@ Vmax	@V=0	UL/cUL	TUV
	Tc (°C)	R <sub>25</sub> (Ω)	I <sub>n</sub> (mA)		I <sub>t</sub> (mA)		V <sub>max</sub> (V <sub>DC</sub> )	I <sub>max</sub> (mA)	T <sub>L</sub> ~T <sub>U</sub> (°C)		UL/cUL	TUV
TPM4P270□110R	110±10	27	40	90	180	263	30	500	-40 ~ +85	-40 ~ +125		
TPM4P550□120R	120±10	55	34	60	130	190	30	400				
TPM4P121□120R	120±10	120	23	40	90	132	80	300				
TPM4P401□090R	90±10	400	6	15	40	59	265	200				
TPM4P152□120R	120±10	1500	4	12	22	32	400	150				

Note1: □ = Tolerance of R<sub>25</sub>(H : ± 25%; S : ± 35%)

# CPTC Thermistor : TPM-P Type

## SMD CPTC Thermistor for Over-Current Protection



### Protective Threshold Current Range(SMD 0603 Series)

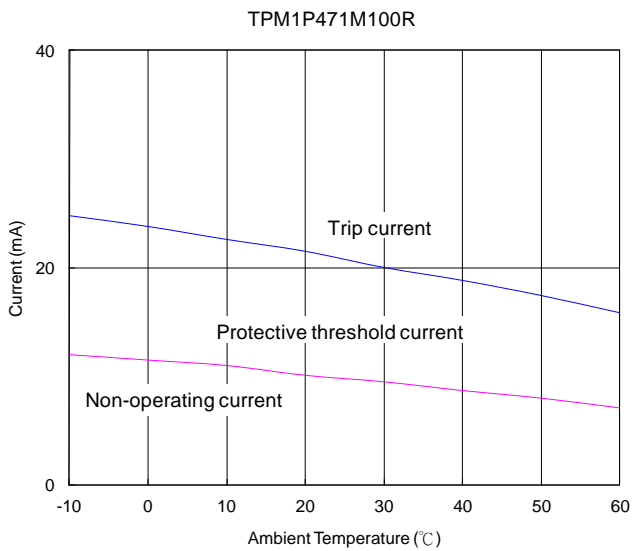
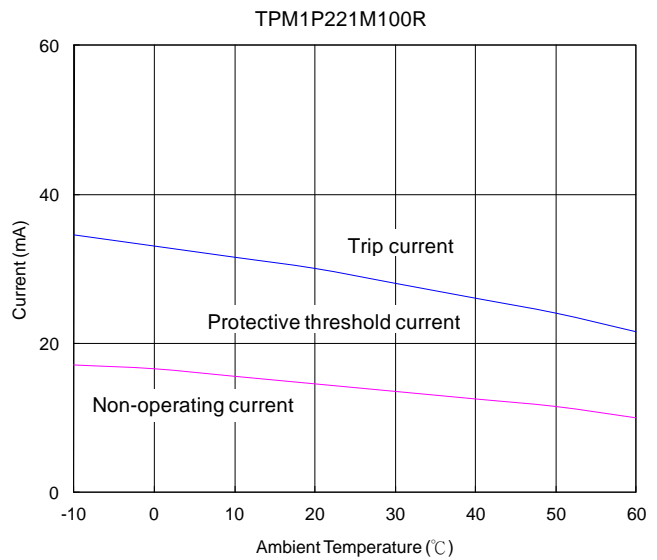
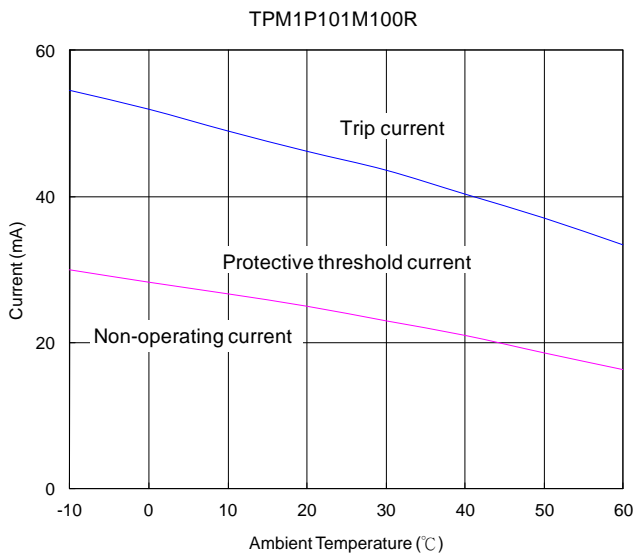
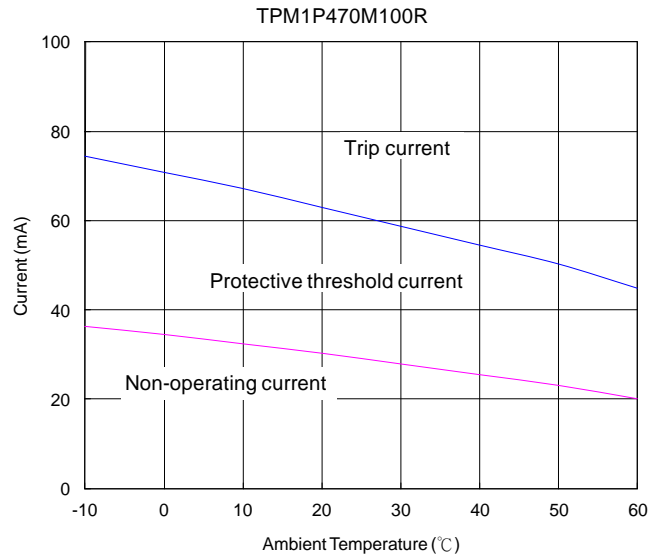
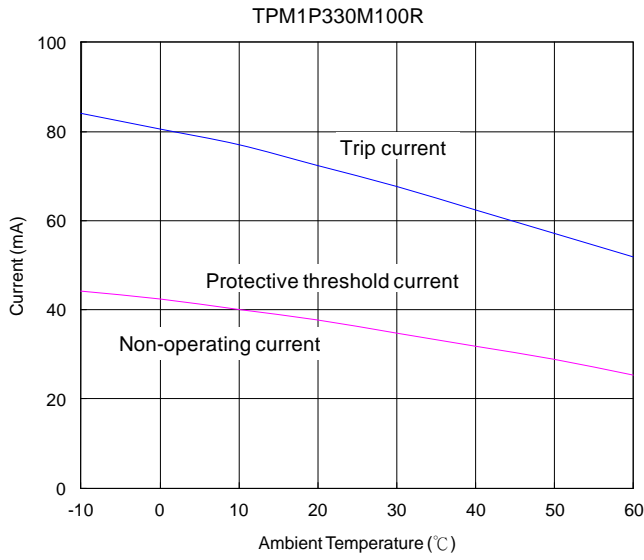

# CPTC Thermistor : TPM-P Type

## SMD CPTC Thermistor for Over-Current Protection



### Protective Threshold Current Range(SMD 0805 Series)

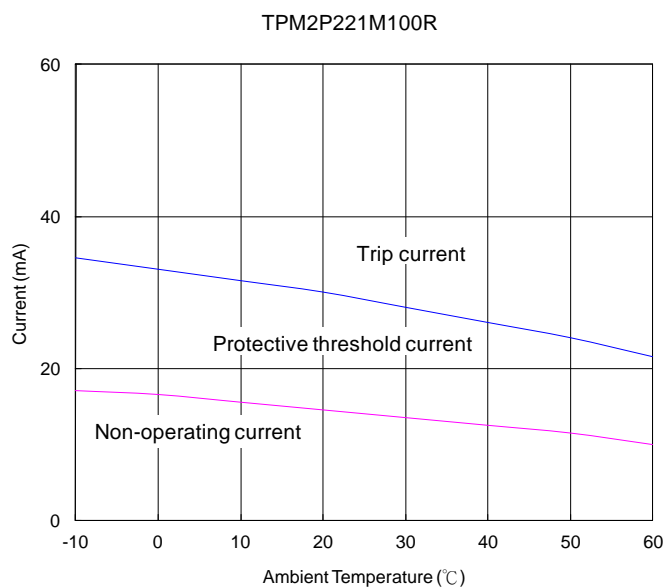
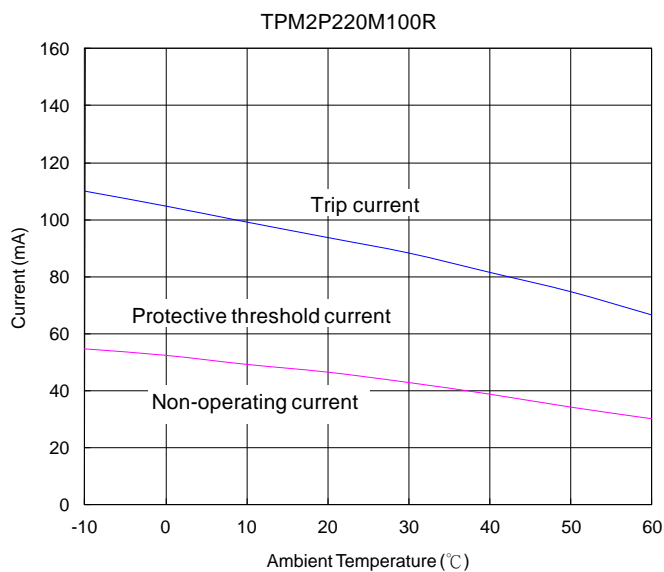
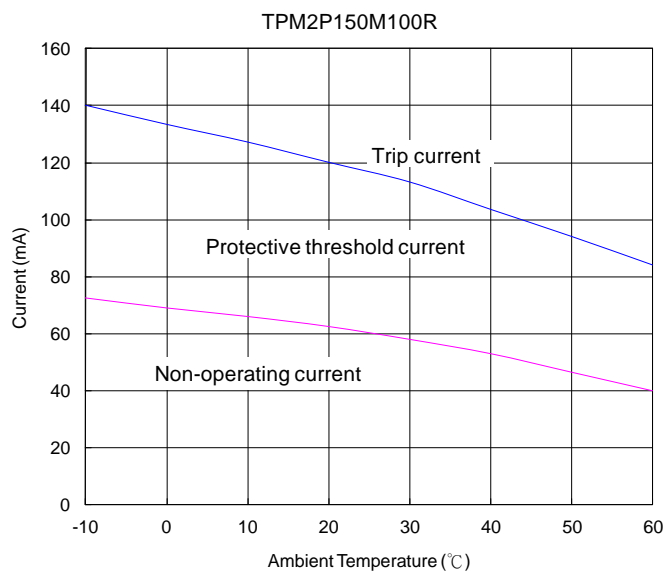

# CPTC Thermistor : TPM-P Type

## SMD CPTC Thermistor for Over-Current Protection



### Protective Threshold Current Range(SMD 1210 Series)

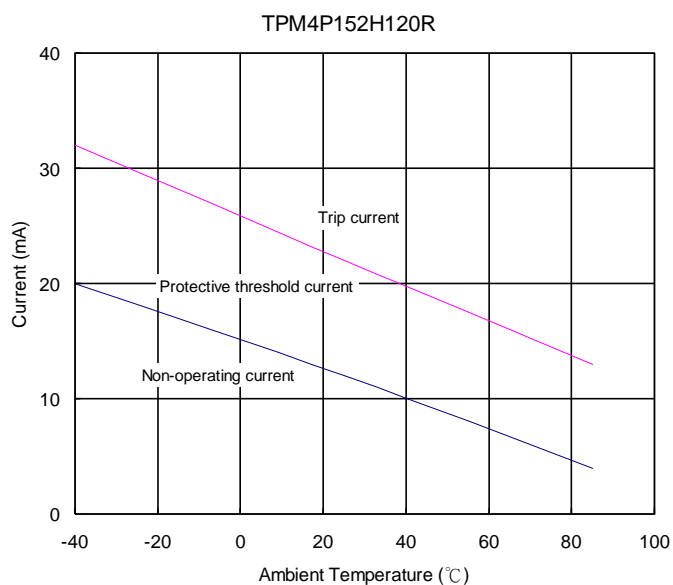
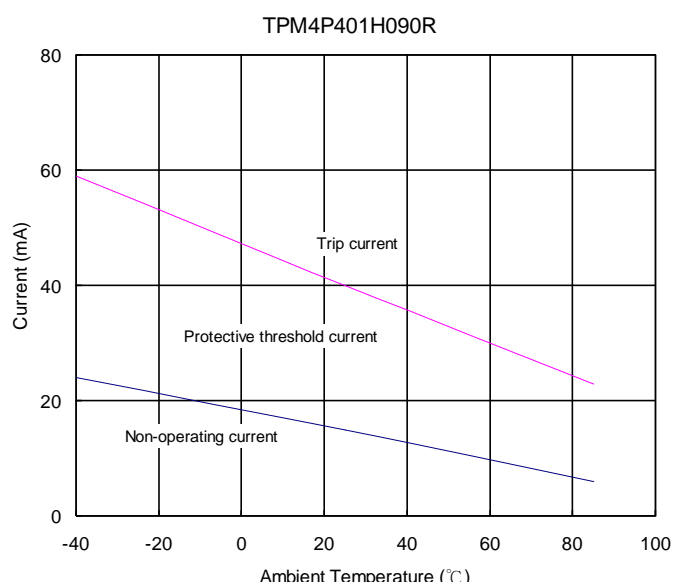
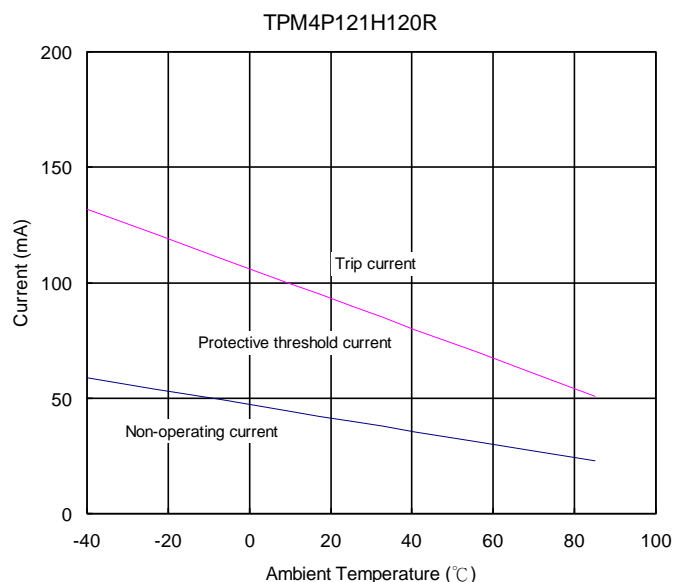
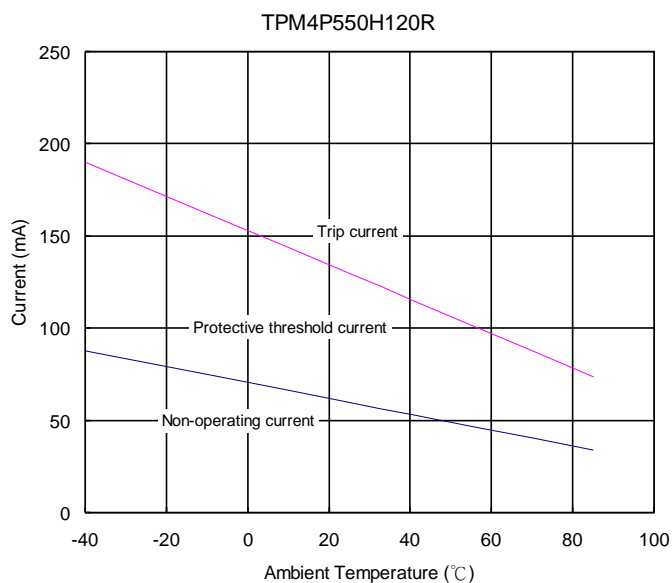
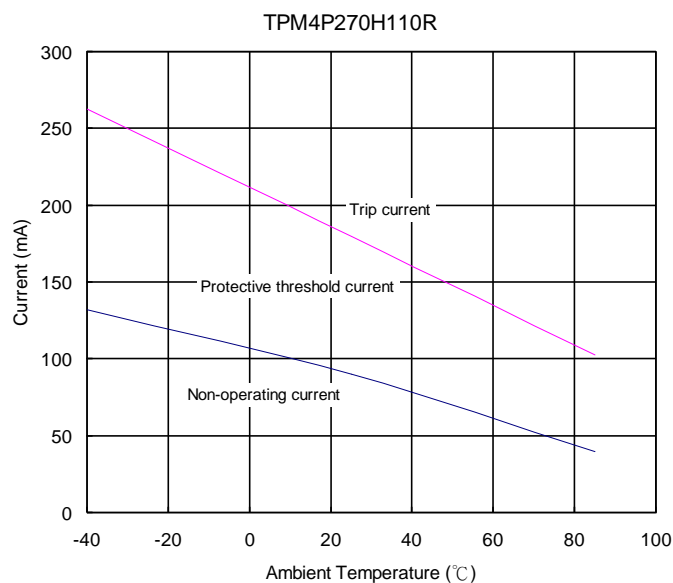

# CPTC Thermistor : TPM-P Type

## SMD CPTC Thermistor for Over-Current Protection



### ■ Typical Application Circuit

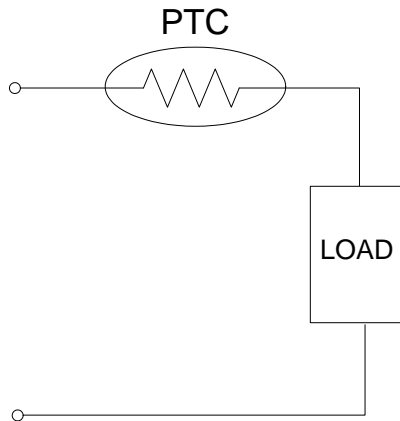

Fig 1. Over-current Protection

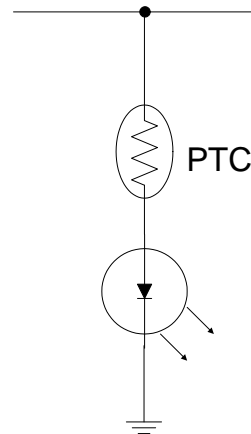
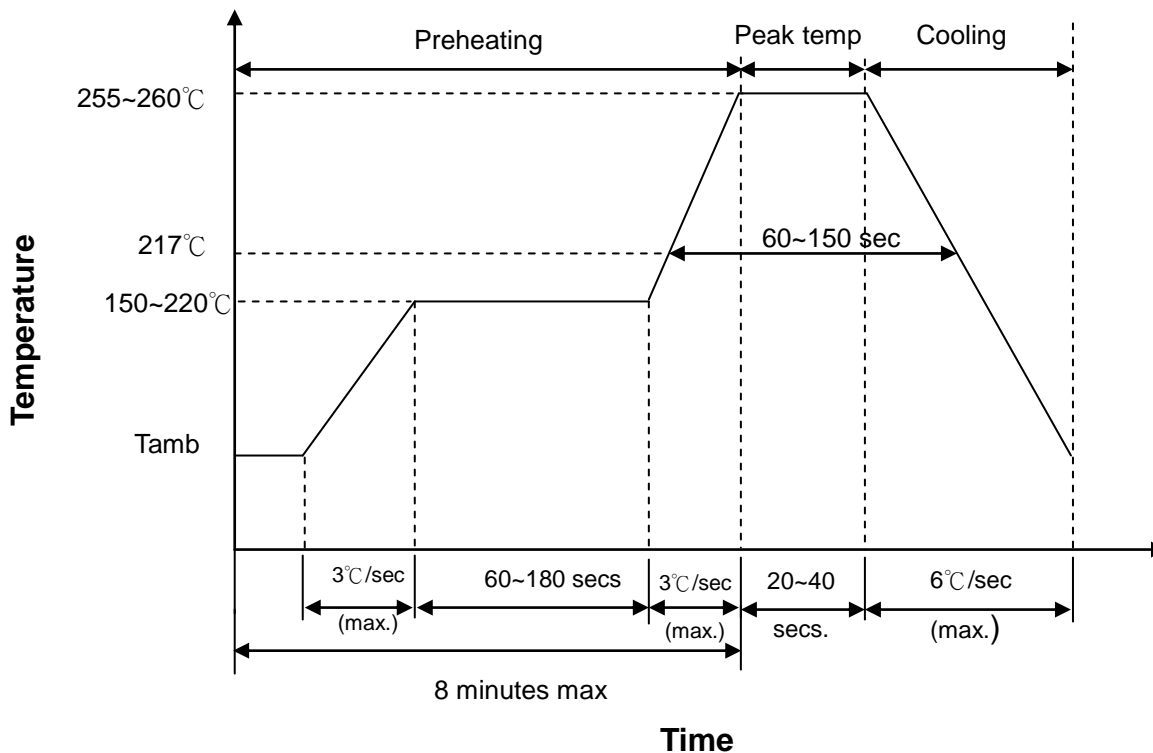

Fig 2. LED Protection

### ■ Soldering Recommendation

#### ● IR-Reflow Soldering Profile



Note : Suitable for reflow soldering only.

# CPTC Thermistor : TPM-P Type

## SMD CPTC Thermistor for Over-Current Protection



### Reworking Conditions with Soldering Iron

Item	Conditions
Temperature of Soldering Iron-tip	360°C (max.)
Soldering Time	3 sec (max.)
Diameter of Soldering Iron-tip	Φ 3mm (max.)

Caution: Not to touch the component surface with soldering iron directly to prevent component damage.

### ■ Recommended Soldering Pad Dimensions

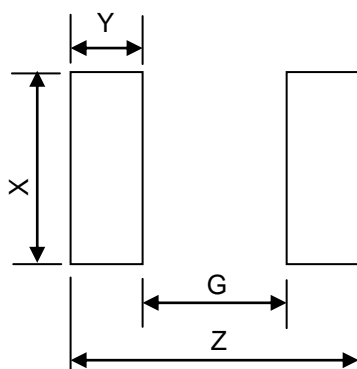

Size(EIA)	Z (mm)	G (mm)	X (mm)	Y (mm)
0603	3.0	1.0	1.0	1.0
0805	3.4	1.0	1.4	1.2
1210	4.5	2.1	2.8	1.2

# CPTC Thermistor : TPM-P Type

## SMD CPTC Thermistor for Over-Current Protection



### ■ Reliability

Item	Standard	Test Conditions / Methods	Specifications															
Rapid Change of Temperature	IEC 60068-2-14	<p>The conditions shown below shall be repeated 5 cycles on PCB</p> <table border="1"> <thead> <tr> <th>Step</th> <th>Temperature (°C)</th> <th>Period (minutes)</th> </tr> </thead> <tbody> <tr> <td>1</td> <td>-40 ± 5</td> <td>30 ± 3</td> </tr> <tr> <td>2</td> <td>Room temperature</td> <td>5 ± 3</td> </tr> <tr> <td>3</td> <td>125 ± 5</td> <td>30 ± 3</td> </tr> <tr> <td>4</td> <td>Room temperature</td> <td>5 ± 3</td> </tr> </tbody> </table>	Step	Temperature (°C)	Period (minutes)	1	-40 ± 5	30 ± 3	2	Room temperature	5 ± 3	3	125 ± 5	30 ± 3	4	Room temperature	5 ± 3	<p>No visible damage   <math>\Delta R_{25}/R_{25}</math>   ≤ 20 %</p>
Step	Temperature (°C)	Period (minutes)																
1	-40 ± 5	30 ± 3																
2	Room temperature	5 ± 3																
3	125 ± 5	30 ± 3																
4	Room temperature	5 ± 3																
Damp Heat, Steady State	IEC 60068-2-78	60 ± 2 °C , 90 ~ 95% RH , 1000± 24 hrs	<p>No visible damage   <math>\Delta R_{25}/R_{25}</math>   ≤ 20 %</p>															
Bending Strength	IEC-60068-2-21	<p>Warp 2mm Speed &lt; 0.5mm/sec. Duration: 10 sec on PCB.</p> 	<p>No visible damage   <math>\Delta R_{25}/R_{25}</math>   ≤ 10 %</p>															
High Temp. Storage	IEC 60068-2-2	125 ± 3 °C , 1000 ± 24 hrs	<p>No visible damage   <math>\Delta R_{25}/R_{25}</math>   ≤ 20 %</p>															
Low Temp. Storage	IEC 60068-2-1	-40 ± 3 °C , 1000 ± 24 hrs	<p>No visible damage   <math>\Delta R_{25}/R_{25}</math>   ≤ 20 %</p>															
High Temp. Endurance Load	Specification Standard	60 ± 3 °C Vmax., for 1.5hrs on / 0.5hrs off, 1000 ± 24 hrs	<p>No visible damage   <math>\Delta R_{25}/R_{25}</math>   ≤ 20 %</p>															
High Temp. Load	IEC 60738-1 7.24.3	85 ± 5 °C , Vmax. , 1000 ± 24 hrs *1	<p>No visible damage   <math>\Delta R_{25}/R_{25}</math>   ≤ 20 %</p>															
Climatic Sequence	IEC 60738-1 7.22	<p>a. 125°C x 16 hrs b. 1st cycle : 40 °C 95 %RH x 24 hrs c. -40 °C x 2 hrs d. 5 cycles : 40°C 95% RH x 24 hrs / Cycle</p>	<p>No visible damage   <math>\Delta R_{25}/R_{25}</math>   ≤ 20 %</p>															
Solderability	IEC 60068-2-58	245 ± 5 °C , 3 ± 0.3 sec	<p>At least 95% of terminal electrode is covered by new solder</p>															
Resistance to Soldering Heat	IEC 60068-2-58	<p>8.1.2.2 Solder reflow method Preheating:150~180°C,60~120 secs Peak temp:245~255°C, ≤20 secs (reflow)</p>	<p>No visible damage   <math>\Delta R_{25}/R_{25}</math>   ≤ 20 %</p>															

Note1: \*1: Apply for TPM4P Series



# CPTC Thermistor : TPM-P Type

## SMD CPTC Thermistor for Over-Current Protection



### ■ Packaging

#### ● Taping Specification (0603 & 0805 type)

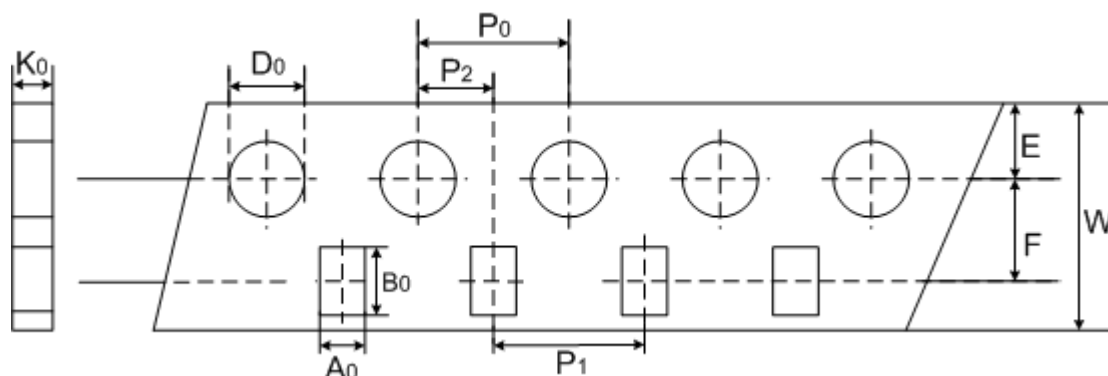

(Unit: mm)

Index Size	A <sub>0</sub>	B <sub>0</sub>	W	E	F	P <sub>1</sub>	P <sub>2</sub>	P <sub>0</sub>	D <sub>0</sub>	K <sub>0</sub>
	±0.2	±0.2	±0.2	±0.1	±0.05	±0.1	±0.05	±0.1	±0.1	±0.1
0603	1.1	1.9	8	1.75	3.5	4	2	4	1.55	0.95
0805	1.5	2.3	8	1.75	3.5	4	2	4	1.55	1.0

#### ● Taping Specification (0805 type, For TPM2P150M100R, TPM2P220M100R)

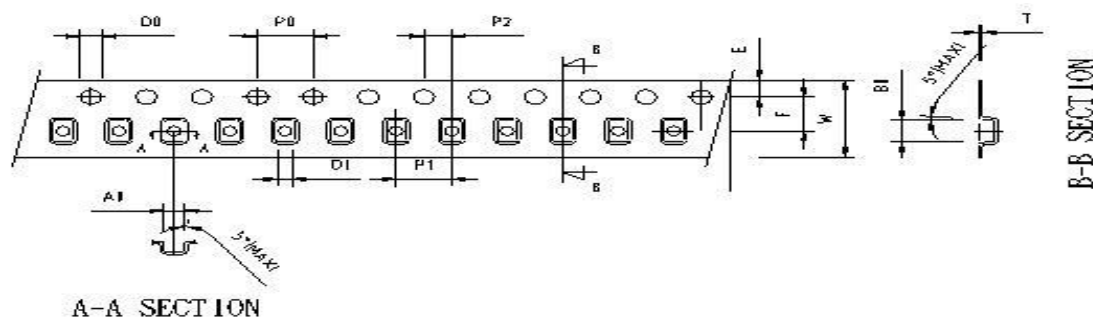

(Unit: mm)

Index Size	A <sub>0</sub>	B <sub>0</sub>	W	E	F	P <sub>1</sub>	P <sub>2</sub>	P <sub>0</sub>	D <sub>0</sub>	D <sub>1</sub>	T
	±0.2	±0.2	±0.2	±0.1	±0.05	±0.1	±0.05	±0.1	±0.1	±0.1	±0.1
0805	1.5	2.3	8	1.75	3.5	4	2	4	1.55	1	0.22

# CPTC Thermistor : TPM-P Type

## SMD CPTC Thermistor for Over-Current Protection



### ■ Packaging

#### ● Taping Specification (1210 type)

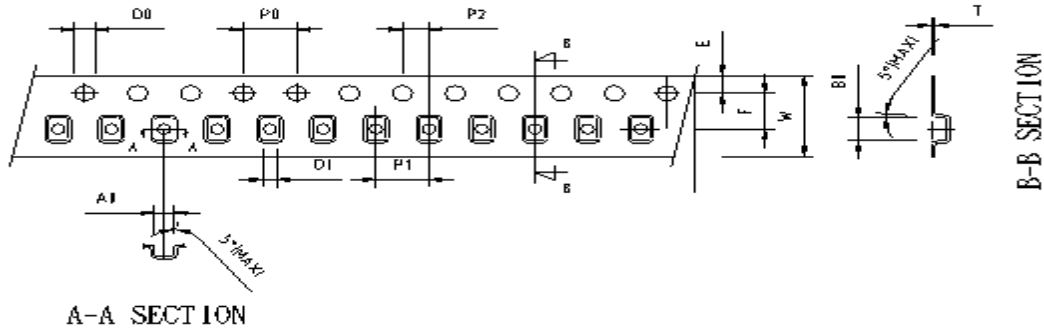

(Unit: mm)

Index	A <sub>0</sub>	B <sub>0</sub>	W	E	F	P <sub>1</sub>	P <sub>2</sub>	P <sub>0</sub>	D <sub>0</sub>	D <sub>1</sub>	T
Size	±0.2	±0.2	±0.2	±0.1	±0.05	±0.1	±0.05	±0.1	±0.1	±0.1	±0.1
1210	2.75	3.55	8	1.75	3.5	4	2	4	1.55	1	0.25

### ■ Quantity

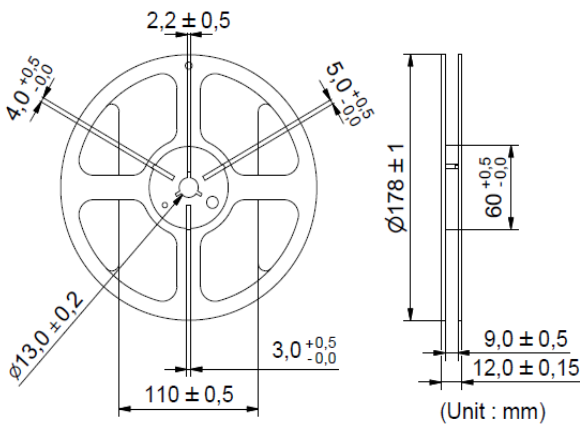

Size(EIA)	Quantity(pcs/reel)
0603	4,000
0805	3,500
1210	2,500

### ■ Warehouse Storage Condition of Products

- Storage Conditions :
  1. Storage Temperature: -10°C ~ +40°C
  2. Relative Humidity: ≤ 75%RH
  3. Keep away from corrosive atmosphere and sunlight.
- Period of Storage : 1 year