

Gas Discharge Tube: GC6 Series



3-Electrode $\Phi 6.0 \times T8$ mm Type

■ Features

1. RoHS & HF compliant
2. Rugged ceramic-metal construction
3. Available with or without leads
4. Available with fail-safe clip
5. DC spark-over voltage: 90~600V
6. Low capacitance
7. Agency recognition: UL
8. Operating temperature: $-40^{\circ}\text{C} \sim +85^{\circ}\text{C}$
Storage temperature: $-40^{\circ}\text{C} \sim +115^{\circ}\text{C}$



■ Recommended Applications

1. Cable modem
2. xDSL
3. Set-top box
4. TV sets
5. Power supply
6. Consumer electronics

■ Part Number Code

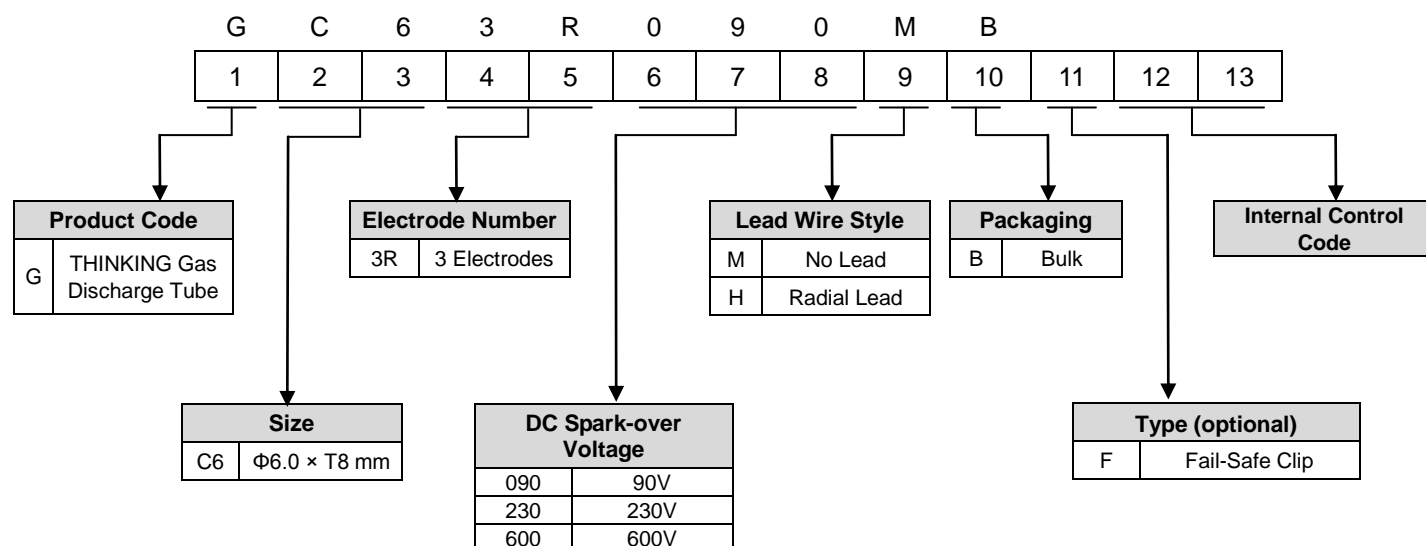

Gas Discharge Tube: GC6 Series



3-Electrode $\Phi 6.0 \times T8$ mm Type

■ Characteristics

Part No.	DC Spark-over Voltage	Max. Impulse Breakdown Voltage		Max. Impulse Discharge Current (8/20 μ s)	Impulse Life (10/1000 μ s)	Normal Alternating Discharge Current	DC Holdover Voltage	Minimum Insulation Resistance	Maximum Capacitance (1MHz)	Safety Approval
	100V/S	100V/ μ s	1KV/ μ s	10 times	200 A	50Hz, 1Sec	<150ms			
	(V)	(V)	(V)	(KA)	Times	(A)	(V)			
GC63R090□□(F)	90 \pm 20%	750	850	5	100	5	52	1	2	√
GC63R145□□(F)	145 \pm 20%	750	850				52			√
GC63R200□□(F)	200 \pm 20%	600	700	10		10	135			√
GC63R230□□(F)	230 \pm 20%	600	700				135			√
GC63R250□□(F)	250 \pm 20%	600	700	5		5	135			√
GC63R350□□(F)	350 \pm 20%	650	750				150			√
GC63R400□□(F)	400 \pm 20%	700	800	5		5	150			√
GC63R420□□(F)	420 \pm 20%	700	800				150			√
GC63R470□□(F)	470 \pm 20%	800	900	5		5	150			√
GC63R600□□(F)	600 \pm 20%	900	1000				150			√

Note 1: The first □ is style of lead wire, and the second □ is packaging.

Note 2: F = with fail-safe clip for optional.

Note 3: UL 497B File No: E245070

Note 4: Insulation resistance test conditions:

DC Spark-over Voltage	DC Measuring Voltage
70-150V	50V
151-400V	100V
401-600V	250V

Gas Discharge Tube: GC6 Series



3-Electrode $\Phi 6.0 \times T8$ mm Type

Dimension

□= H (Radial Lead Type)

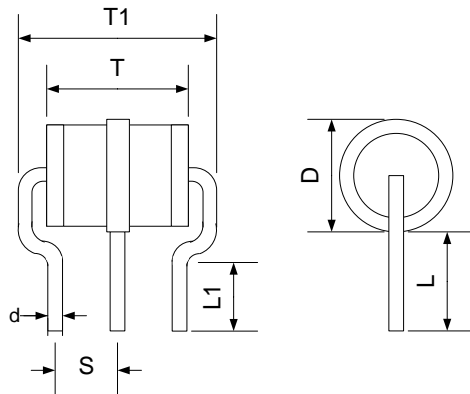

(Unit: mm)

Item	Dimensions	
	Spec.	Tolerance
D	6.0	+0.2/-0.5
T	8.5	± 0.5
T1	11.5	+0.8/-0.5
L	7.5	± 0.5
L1	4.5	Min.
S	3.8	± 0.3
d	0.8	± 0.05

□= M (No Lead Type)

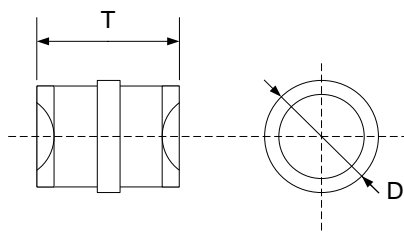

(Unit: mm)

Item	Dimensions	
	Spec.	Tolerance
D	6.0	+0.2/-0.5
T	8.5	± 0.5

F = with fail-safe clip for optional

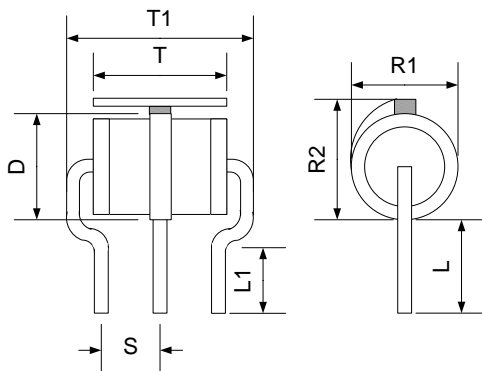

(Unit: mm)

Item	Dimensions	
	Spec.	Tolerance
D	6.0	+0.2/-0.5
T	8.5	± 0.5
R1	6.3	± 0.3
R2	7.6	± 0.4
T1	11.5	+0.8/-0.5
L	7.5	± 0.5
L1	4.5	Min
S	3.8	± 0.3
d	0.8	± 0.05

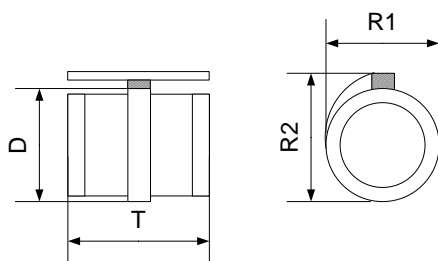

(Unit: mm)

Item	Dimensions	
	Spec.	Tolerance
D	6.0	+0.2/-0.5
T	8.5	± 0.5
R1	6.3	± 0.3
R2	7.6	± 0.4

Gas Discharge Tube: GC6 Series



3-Electrode $\Phi 6.0 \times T8$ mm Type

■ Marking

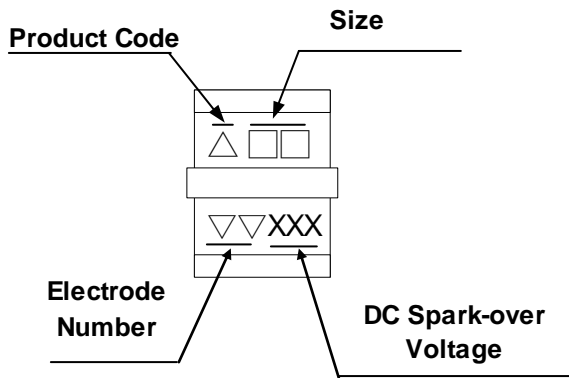

Example

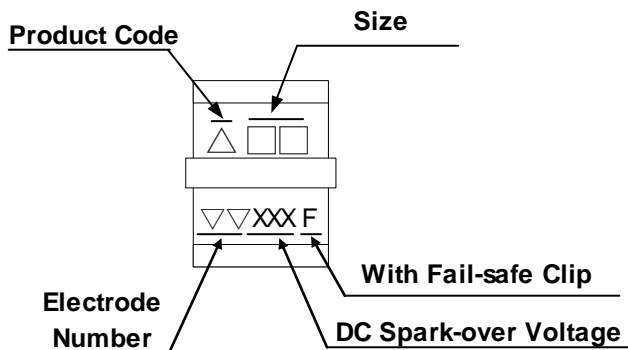
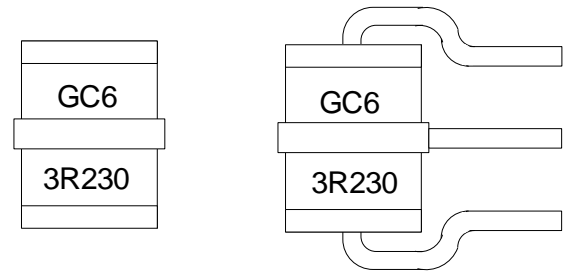

Example

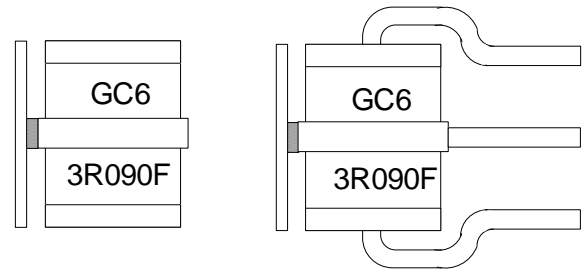

■ Packaging

● Bulk :

Quantity: 100pcs per PVC Box, and 500 pcs per Inner Box

■ Warehouse Storage Conditions of Products

- Storage Conditions:
 1. Storage Temperature: $-10^{\circ}\text{C} \sim +40^{\circ}\text{C}$
 2. Relative Humidity: $\leq 75\% \text{RH}$
 3. Keep away from corrosive atmosphere and sunlight.
- Period of Storage: 1 yea