

Metal Oxide Varistor : TVM-B Series



SMD Type Surge Suppressor

■ Features

1. RoHS & Halogen Free (HF) compliant
2. EIA size: 0402~3025
3. Operating voltage: 5.5Vdc~85Vdc
4. High surge suppression capability
5. Bidirectional and symmetrical V/I characteristics
6. Multilayer ceramic construction technology
7. Variable capacitance
8. Operating temperature range: $-40^{\circ}\text{C} \sim +85^{\circ}\text{C}$
Storage temperature range: $-40^{\circ}\text{C} \sim +125^{\circ}\text{C}$



■ Recommended Applications

1. Power system
2. Motherboard/notebook computer
3. Scanner
4. Handheld devices
5. Digital video
6. Set-top box

■ Part Number Code

T	V	M	3	B	1	8	0	K	1	5	2	R	Y		
1	2	3	4	5	6	7	8	9	10	11	12	13	14	15	16

Product Type		Series		Varistor Voltage (V_{1mA})		Tolerance of V_{1mA}		Packaging		Optional Suffix	
TVM	THINKING SMD Varistor TVM Series	B	B series	12R	12.5V	K	$\pm 10\%$	R	Reel	Y	RoHS & HF Compliant
				180	$18 \times 10^0 \text{V} = 18\text{V}$	L	$\pm 15\%$	B	Bulk		
				330	$33 \times 10^0 \text{V} = 33\text{V}$	M	$\pm 20\%$				

Size (EIA)	
0	0402
1	0603
2	0805
3	1206
4	1210
5	1812
6	2220
7	3025

Typical Capacitance (@1KHz)	
150	$15 \times 10^0 = 15\text{pF}$
231	$23 \times 10^1 = 230\text{pF}$
152	$15 \times 10^2 = 1500\text{pF}$

■ Structure and Dimensions

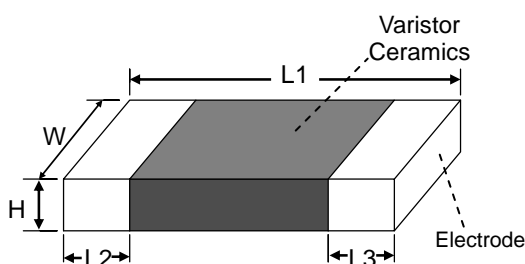

(Unit: mm)

Series	Size (EIA)	L1	W	Hmax.	L2 and L3
TVM0	0402	1.00±0.15	0.50±0.10	H: 0.50±0.10	0.20±0.10
TVM1	0603	1.60±0.15	0.80±0.15	H: 0.80±0.15	0.35±0.15
TVM2	0805	2.00±0.20	1.25±0.20	1.00	0.40±0.20
TVM3	1206	3.20±0.30	1.60±0.20	1.50	0.50±0.20
TVM4	1210	3.20±0.30	2.50±0.25	1.50	0.50±0.20
TVM5	1812	4.50±0.40	3.20±0.30	1.50	0.60±0.30
TVM6	2220	5.70±0.40	5.00±0.30	2.00	0.60±0.30
TVM7	3025	7.50±0.50	6.30±0.40	2.50	0.60±0.30

Metal Oxide Varistor : TVM-B Series

SMD Type Surge Suppressor



Electrical Characteristics

Part No.	Varistor Voltage (@ 1mA DC)		Max. Continuous Voltage		Max. Clamping Voltage (8/20 μ s)		Max. Surge Current (8/20 μ s)	Max. Energy (10/1000 μ s)	Rate Power	Typical Capacitance @1KHz
	V_{1mA}	ΔV_{1mA}	$V_{AC(rms)}$	V_{DC}	V_p	I_p	I_{max}	W_{max}	P	C_p
	(V)	($\pm\%$)	(V)	(V)	(V)	(A)	(A)	(J)	(W)	(pF)
TVM0B080M231	8	20	4	5.5	19	1	10	0.05	0.003	230
TVM1B080M951	8	20	4	5.5	19	1	30	0.1	0.003	950
TVM2B080M152	8	20	4	5.5	19	1	60	0.1	0.005	1500
TVM3B080M482	8	20	4	5.5	17	1	150	0.3	0.008	4800
TVM4B080M822	8	20	4	5.5	17	2.5	250	0.4	0.01	8200
TVM5B080M183	8	20	4	5.5	17	5	500	0.8	0.015	18000
TVM6B080M293	8	20	4	5.5	17	10	1000	1.4	0.02	29000
TVM0B110M161	11	20	6	8	27	1	10	0.05	0.003	160
TVM1B110M601	11	20	6	8	27	1	30	0.1	0.003	600
TVM2B110M142	11	20	6	8	27	1	60	0.2	0.005	1400
TVM3B110M392	11	20	6	8	25	1	200	0.4	0.008	3900
TVM4B110M752	11	20	6	8	25	2.5	300	0.7	0.01	7500
TVM5B110M153	11	20	6	8	25	5	500	1	0.015	15000
TVM6B110M253	11	20	6	8	25	10	1200	3.6	0.02	25000
TVM0B12RM141	12.5	20	7	9	30	1	10	0.05	0.003	140
TVM1B12RM571	12.5	20	7	9	30	1	30	0.1	0.003	570
TVM2B12RM112	12.5	20	7	9	29	1	60	0.2	0.005	1100
TVM0B150L121	15	15	8	11	33	1	10	0.05	0.003	120
TVM1B150L521	15	15	8	11	33	1	30	0.1	0.003	520
TVM2B150L951	15	15	8	11	33	1	60	0.2	0.005	950
TVM3B150L252	15	15	8	11	30	1	200	0.5	0.008	2500
TVM4B150L482	15	15	8	11	30	2.5	400	1	0.01	4800
TVM5B150L103	15	15	8	11	30	5	800	1.8	0.015	10000
TVM6B150L183	15	15	8	11	30	10	1200	4.2	0.02	18000
TVM0B180K800	18	10	11	14	35	1	10	0.05	0.003	80
TVM1B180K421	18	10	11	14	35	1	30	0.2	0.003	420
TVM2B180K671	18	10	11	14	35	1	60	0.2	0.005	670
TVM3B180K152	18	10	11	14	33	1	200	0.5	0.008	1500
TVM4B180K292	18	10	11	14	33	2.5	400	1.2	0.01	2900
TVM5B180K552	18	10	11	14	33	5	800	1.9	0.015	5500
TVM6B180K123	18	10	11	14	33	10	1200	5.4	0.02	12000
TVM0B220K600	22	10	14	18	44	1	10	0.05	0.003	60
TVM1B220K301	22	10	14	18	40	1	30	0.2	0.003	300
TVM2B220K431	22	10	14	18	40	1	60	0.3	0.005	430
TVM3B220K122	22	10	14	18	42	1	200	0.5	0.008	1200
TVM4B220K242	22	10	14	18	38	2.5	400	1.5	0.01	2400
TVM5B220K502	22	10	14	18	38	5	800	2.3	0.015	5000
TVM6B220K103	22	10	14	18	38	10	1200	5.8	0.02	10000
TVM0B270K500	27	10	17	22	55	1	10	0.05	0.003	50
TVM1B270K181	27	10	17	22	46	1	30	0.2	0.003	180
TVM2B270K331	27	10	17	22	46	1	60	0.3	0.005	330
TVM3B270K102	27	10	17	22	48	1	200	0.6	0.008	1000

Metal Oxide Varistor : TVM-B Series

SMD Type Surge Suppressor



Electrical Characteristics

Part No.	Varistor Voltage (@ 1mA DC)		Max. Continuous Voltage		Max. Clamping Voltage (8/20µs)		Max. Surge Current (8/20µs)	Max. Energy (10/1000µs)	Rate Power	Typical Capacitance @1KHz
	V _{1mA}	Δ V _{1mA}	V _{AC (rms)}	V _{DC}	V _p	I _p	I _{max}	W _{max}	P	C _p
	(V)	(±%)	(V)	(V)	(V)	(A)	(A)	(J)	(W)	(pF)
TVM4B270K202	27	10	17	22	44	2.5	400	1.7	0.01	2000
TVM5B270K402	27	10	17	22	44	5	800	2.7	0.015	4000
TVM6B270K772	27	10	17	22	44	10	1200	7.2	0.02	7700
TVM0B330K400	33	10	20	26	63	1	10	0.05	0.003	40
TVM1B330K151	33	10	20	26	56	1	30	0.3	0.003	150
TVM2B330K301	33	10	20	26	56	1	60	0.3	0.005	300
TVM3B330K801	33	10	20	26	54	1	200	0.7	0.008	800
TVM4B330K132	33	10	20	26	54	2.5	400	1.9	0.01	1300
TVM5B330K322	33	10	20	26	54	5	800	3	0.015	3200
TVM6B330K582	33	10	20	26	54	10	1200	7.8	0.02	5800
TVM1B390K101	39	10	25	31	67	1	30	0.3	0.003	100
TVM2B390K181	39	10	25	31	67	1	60	0.3	0.005	180
TVM3B390K651	39	10	25	31	65	1	200	1	0.008	650
TVM4B390K102	39	10	25	31	65	2.5	300	1.7	0.01	1000
TVM5B390K252	39	10	25	31	65	5	800	3.7	0.015	2500
TVM6B390K412	39	10	25	31	65	10	1200	9.6	0.02	4100
TVM7B390K701	39	10	25	31	70	5	250	3	0.02	700
TVM2B470K151	47	10	30	38	77	1	60	0.3	0.005	150
TVM3B470K381	47	10	30	38	77	1	200	1.1	0.008	380
TVM4B470K901	47	10	30	38	77	2.5	300	2	0.01	900
TVM5B470K202	47	10	30	38	77	5	800	4.2	0.015	2000
TVM6B470K302	47	10	30	38	77	10	1200	12	0.02	3000
TVM7B470K651	47	10	30	38	95	5	250	3	0.02	650
TVM2B560K201	56	10	35	45	85	1	60	0.3	0.005	200
TVM3B560K301	56	10	35	45	90	1	100	0.4	0.008	300
TVM4B560K601	56	10	35	45	90	2.5	250	2	0.01	600
TVM5B560K122	56	10	35	45	90	5	500	4	0.015	1200
TVM6B560K202	56	10	35	45	90	10	1000	7.7	0.02	2000
TVM7B560K601	56	10	35	45	105	5	250	3	0.02	600
TVM3B680K251	68	10	40	56	110	1	100	0.5	0.008	250
TVM4B680K451	68	10	40	56	110	2.5	250	2.3	0.01	450
TVM5B680K102	68	10	40	56	110	5	500	4.8	0.015	1000
TVM6B680K152	68	10	40	56	110	10	1000	9	0.02	1500
TVM7B680K601	68	10	40	56	125	5	250	3	0.02	600
TVM3B820K181	82	10	50	65	135	1	100	0.6	0.008	180
TVM4B820K301	82	10	50	65	135	2.5	200	1.6	0.01	300
TVM5B820K601	82	10	50	65	135	5	400	4.5	0.015	600
TVM6B820K102	82	10	50	65	135	10	800	5.6	0.02	1000
TVM3B101K151	100	10	60	85	146	1	100	0.7	0.008	150
TVM4B101K161	100	10	60	85	165	2.5	200	2	0.01	160
TVM5B101K301	100	10	60	85	165	5	400	5.8	0.015	300
TVM6B101K601	100	10	60	85	165	10	800	6.8	0.02	600

Metal Oxide Varistor : TVM-B Series



SMD Type Surge Suppressor

Power Derating Curve

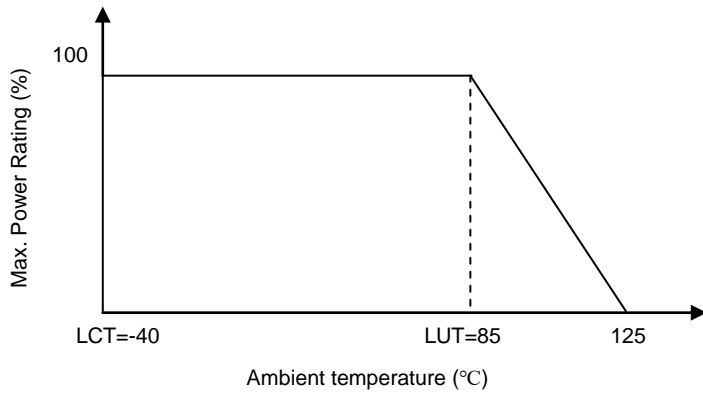

Surge Current Standard Waveform

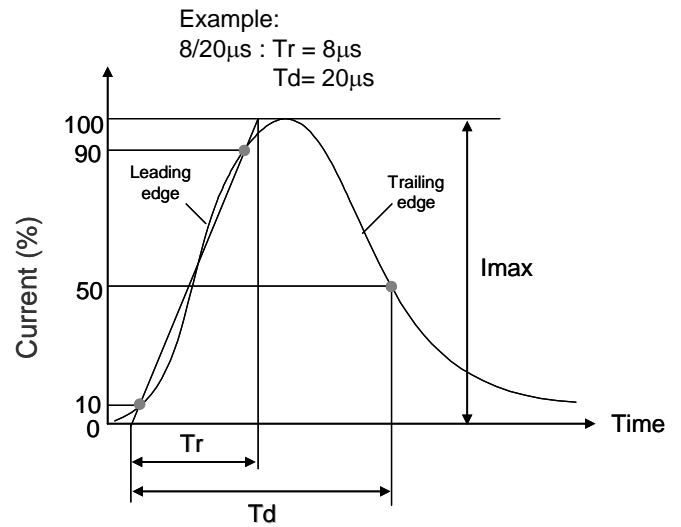

Max. Surge Current Derating Curves

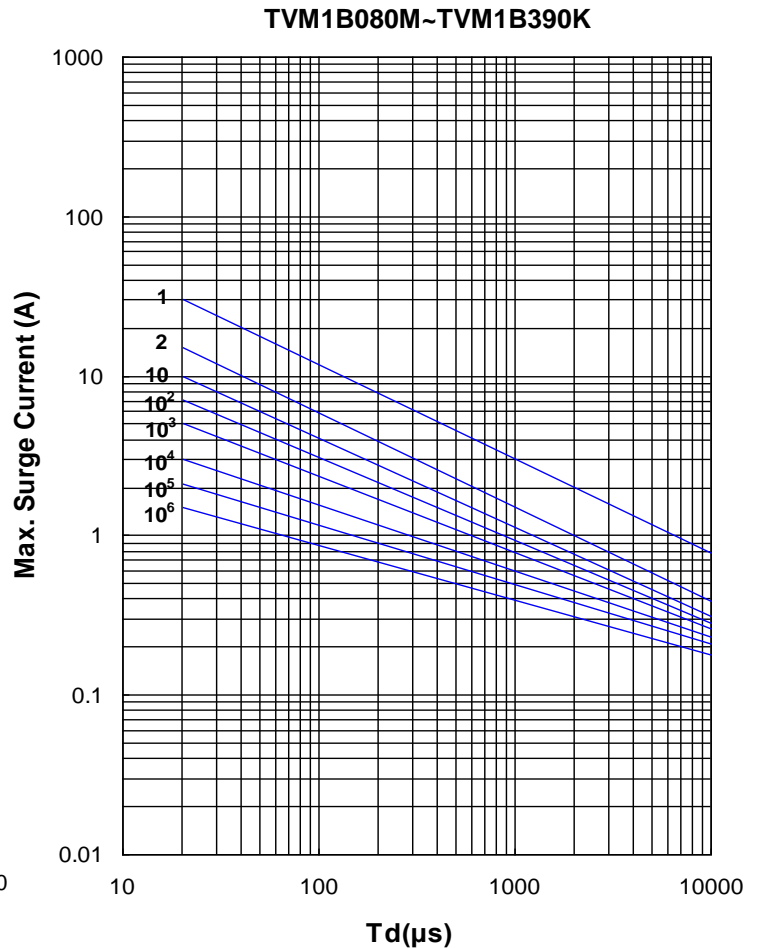
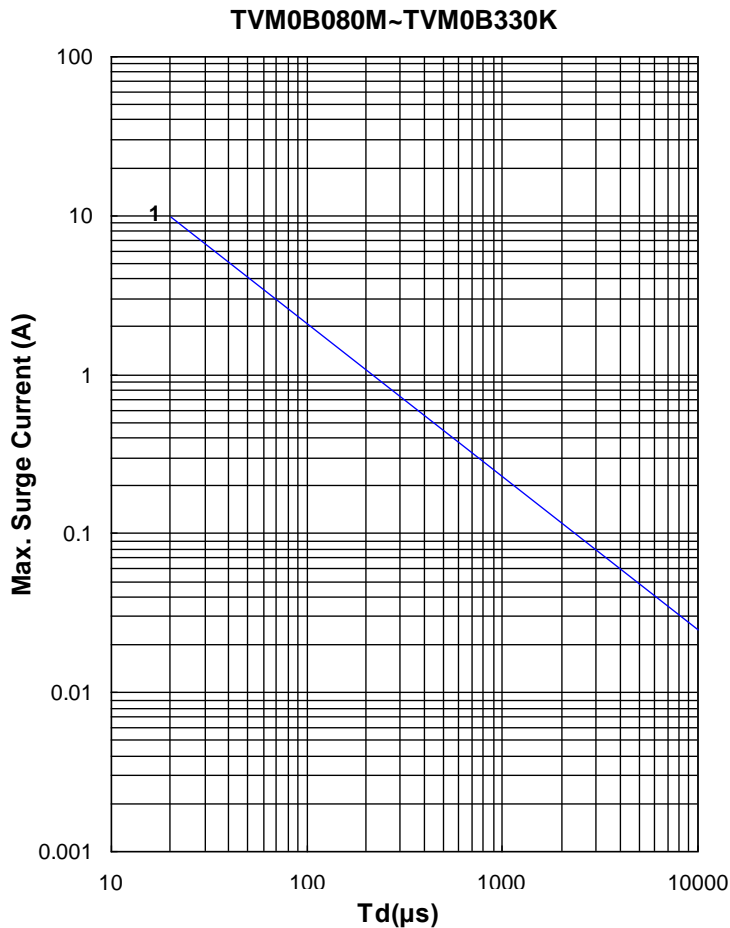

Metal Oxide Varistor : TVM-B Series



SMD Type Surge Suppressor

Max. Surge Current Derating Curves

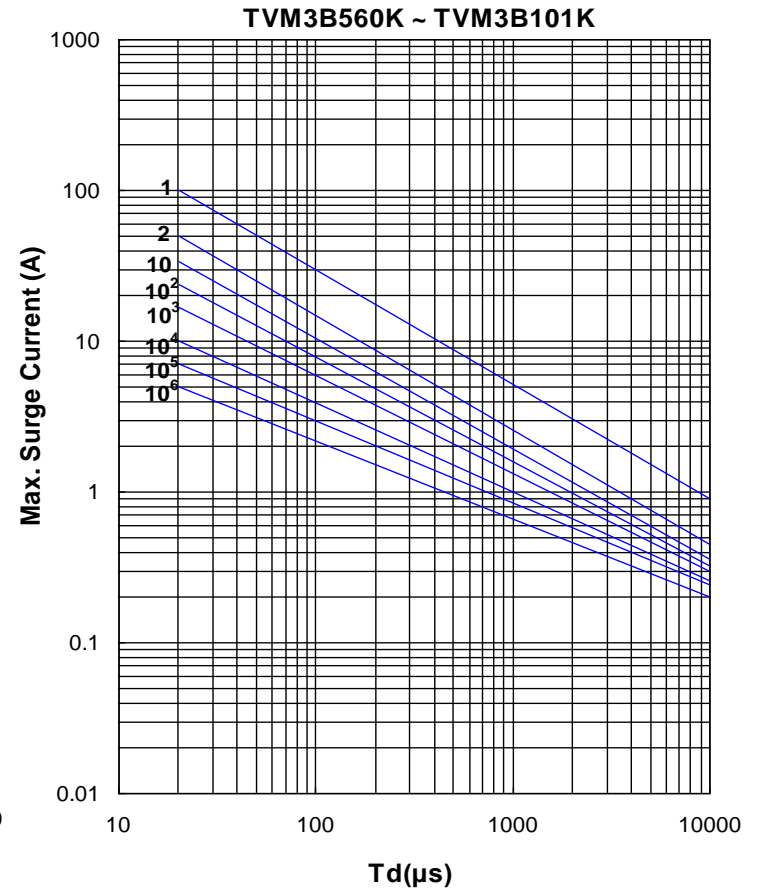
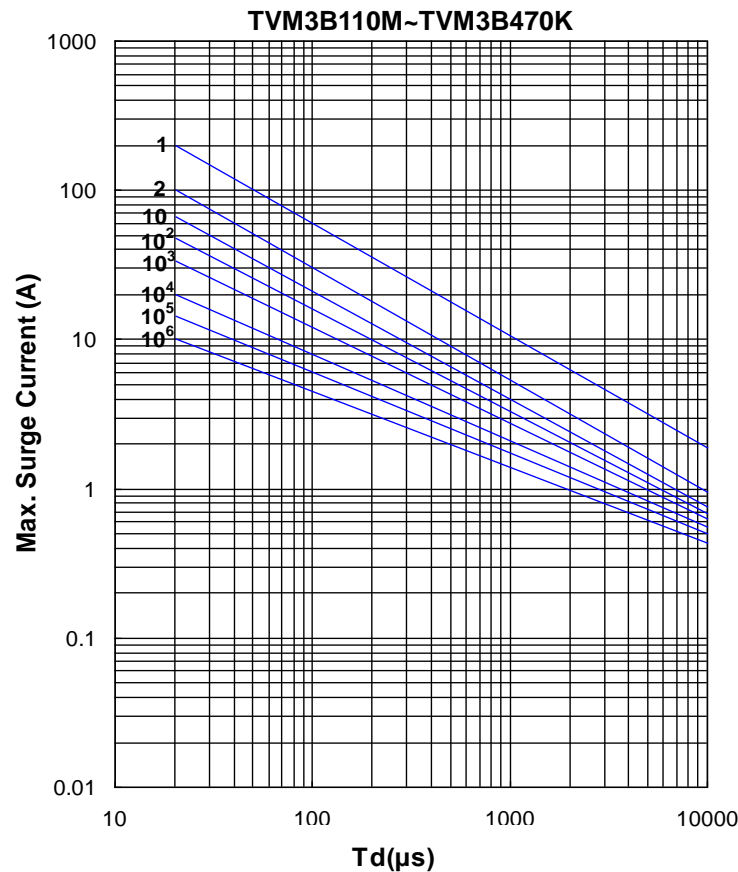
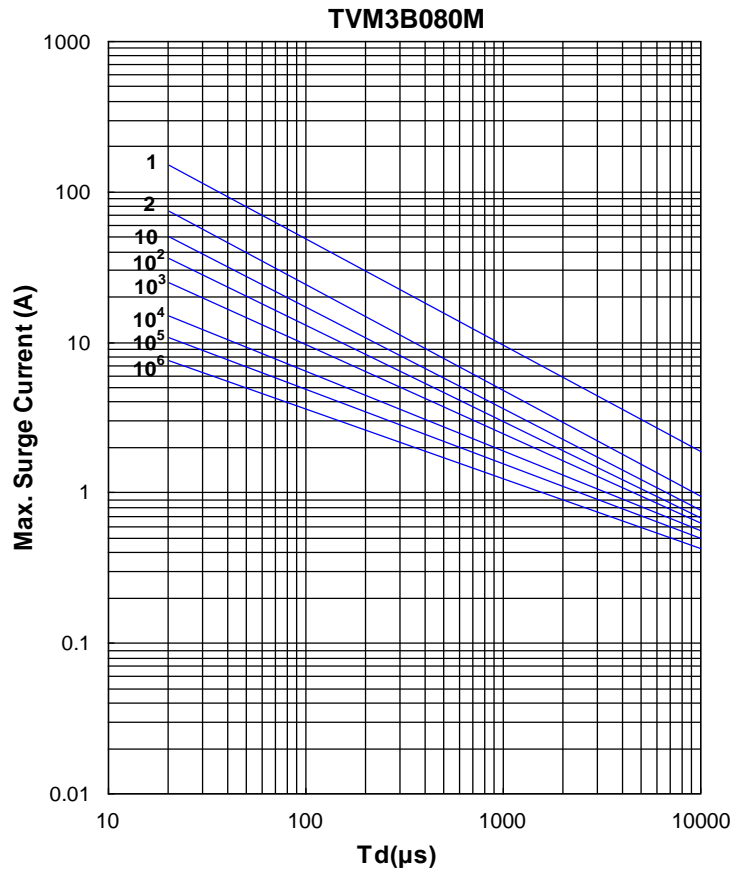
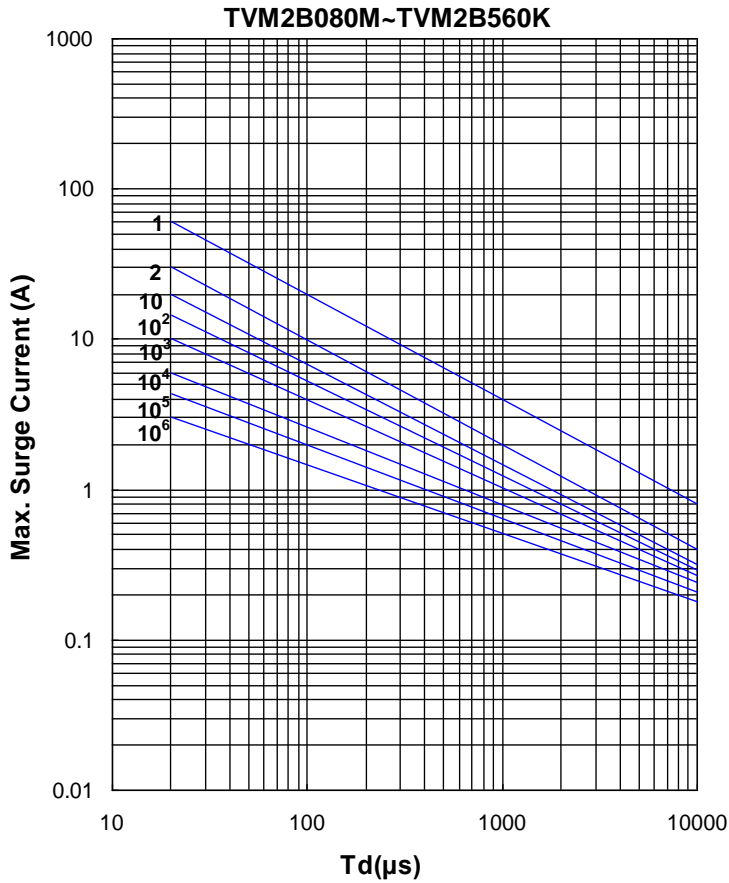

Metal Oxide Varistor : TVM-B Series

SMD Type Surge Suppressor



Max. Surge Current Derating Curves

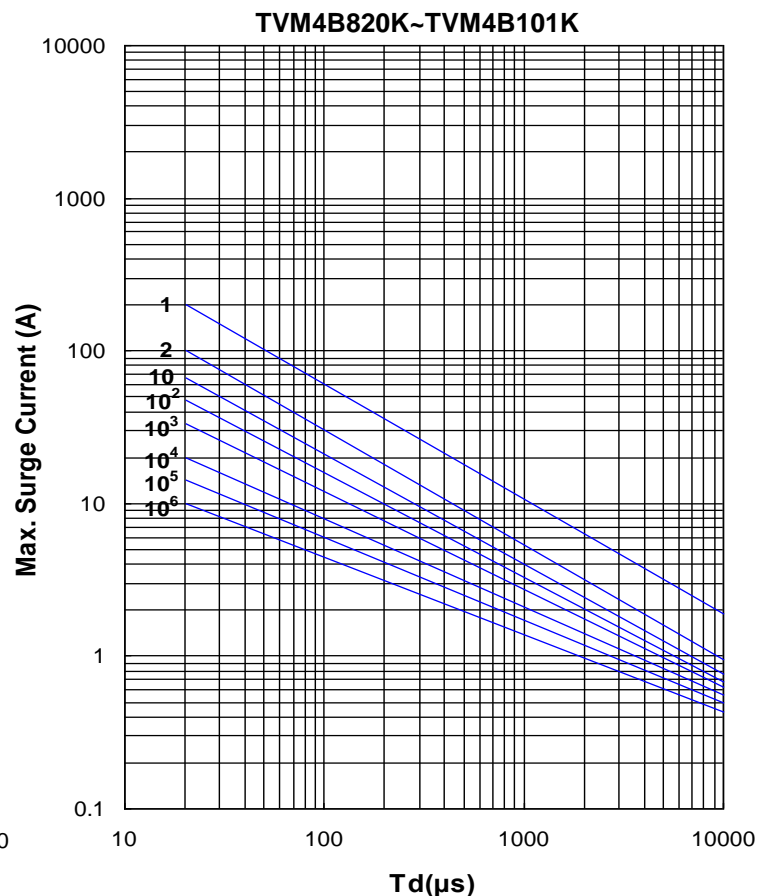
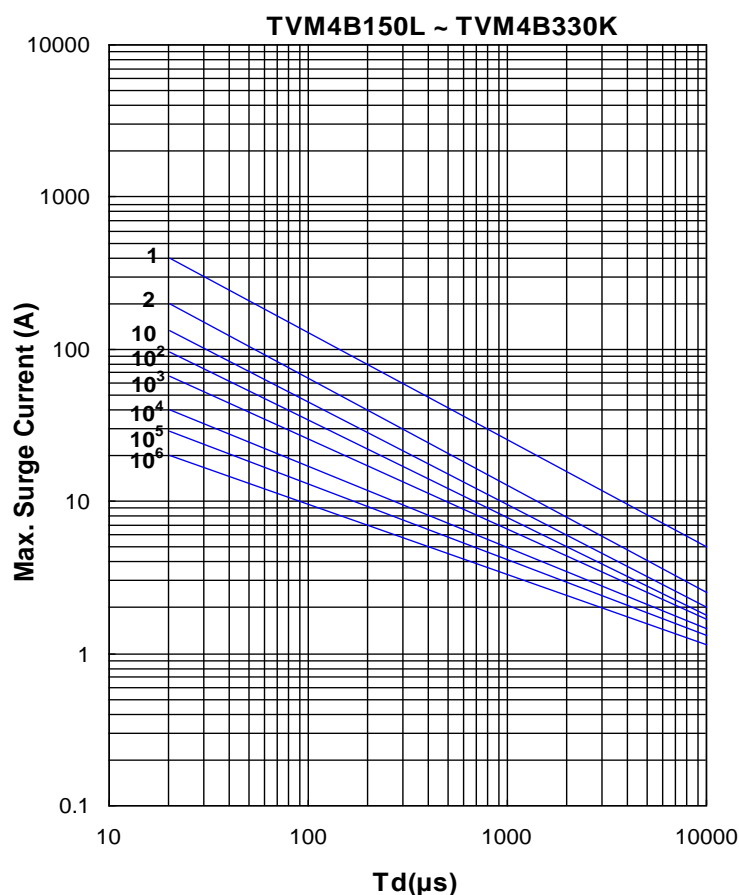
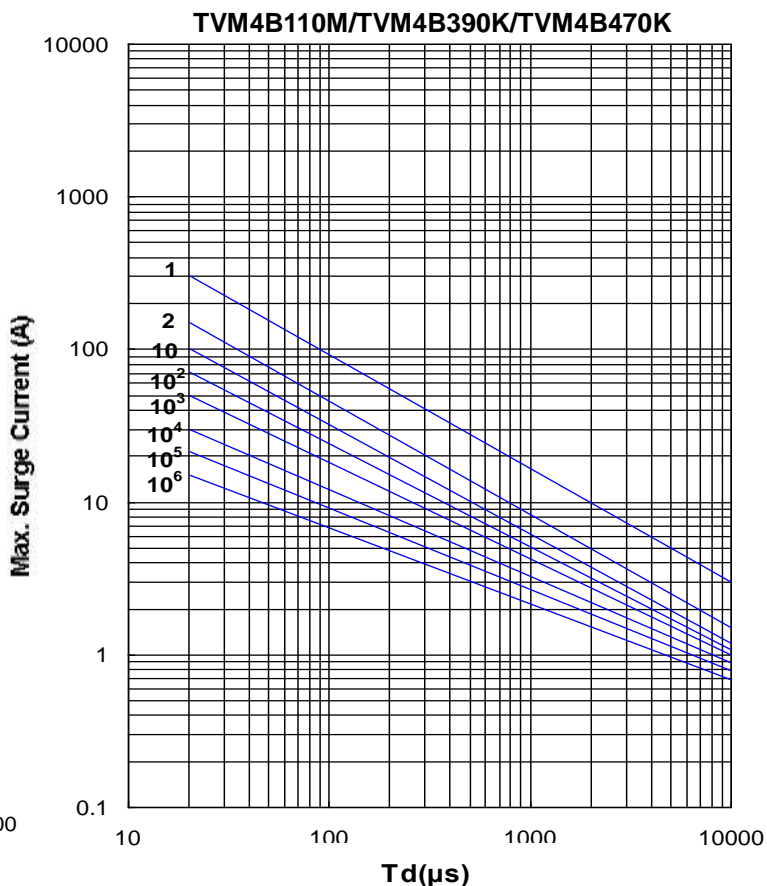
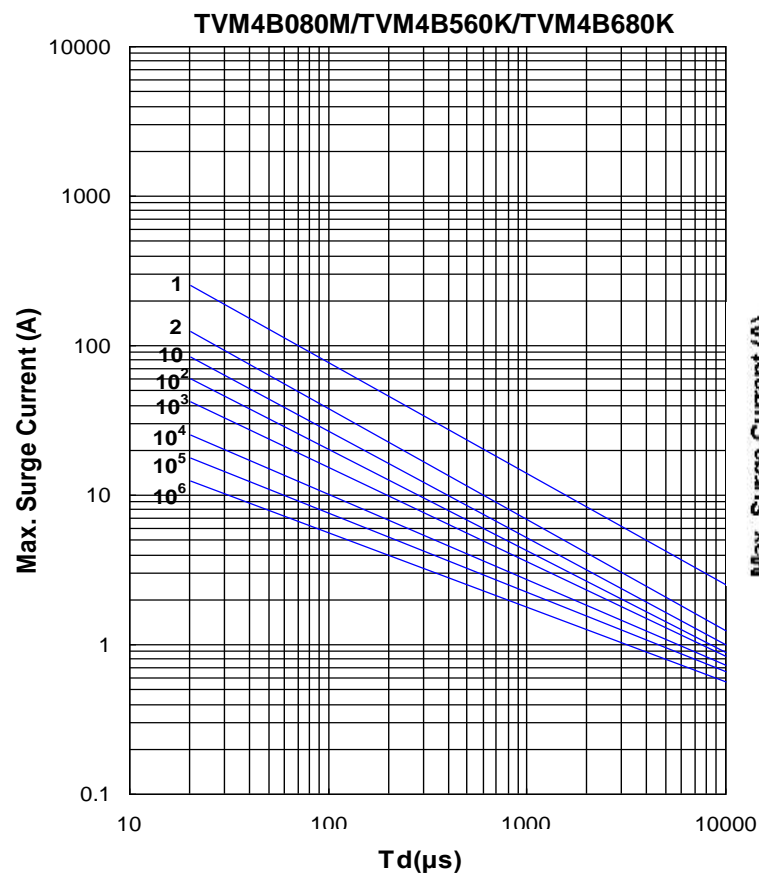

Metal Oxide Varistor : TVM-B Series



SMD Type Surge Suppressor

Max. Surge Current Derating Curves

TVM5B080M~TVM5B110M
TVM5B560K~TVM5B680K.

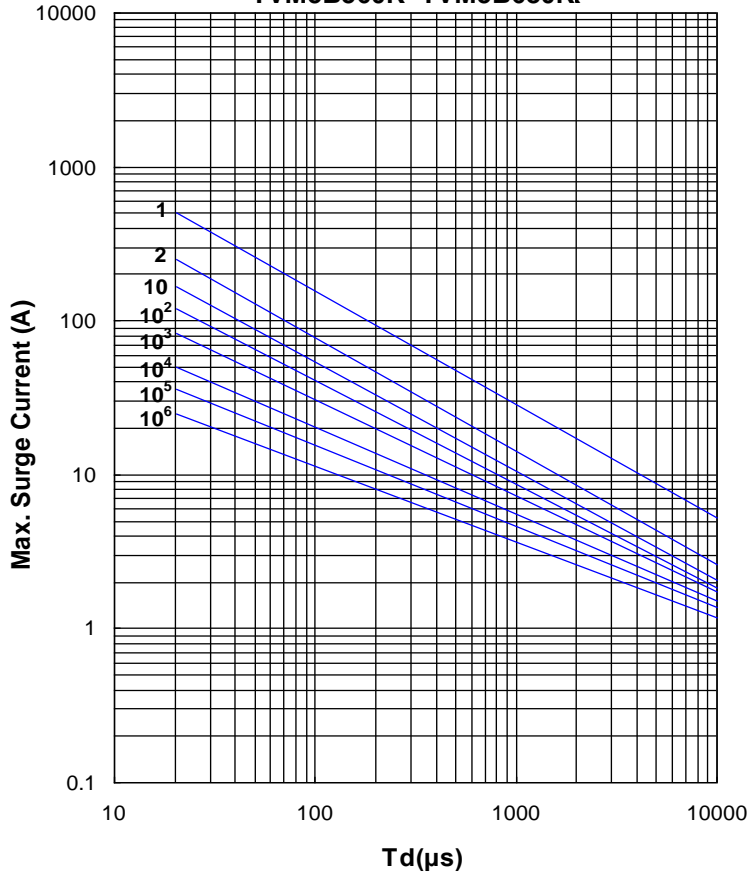

TVM5B150L~TVM5B470K

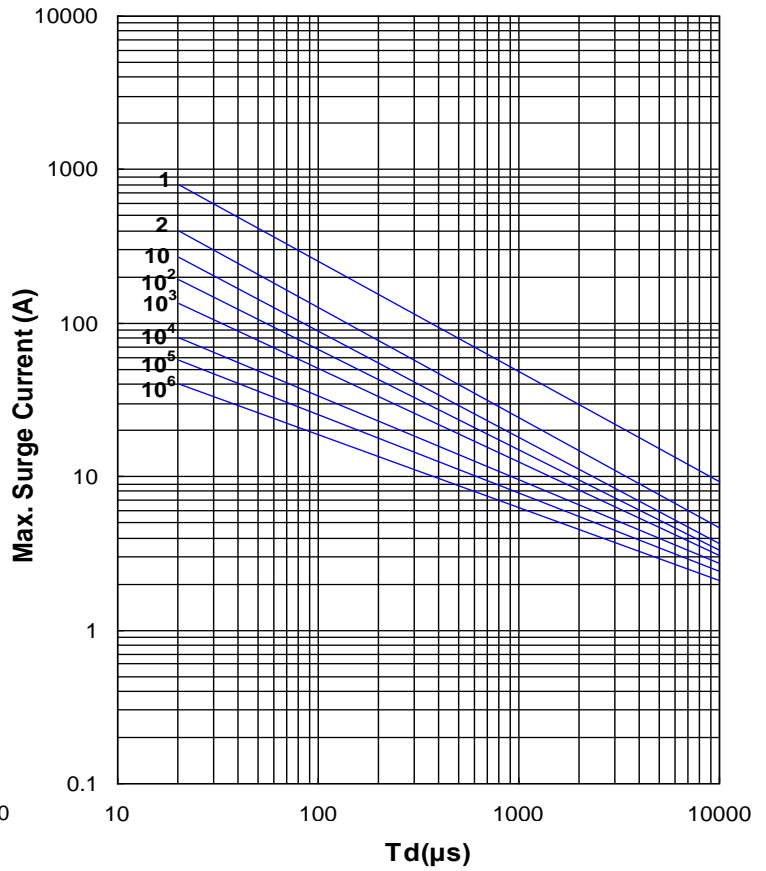

TVM5B820K ~ TVM5B101K

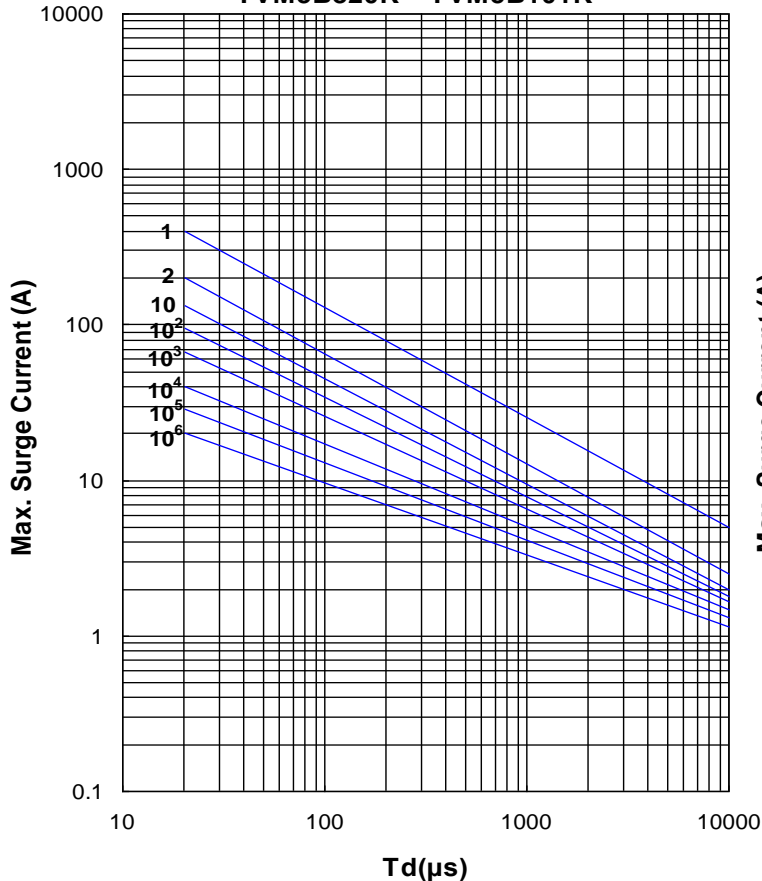

TVM6B080M
TVM6B560K~TVM6B680K

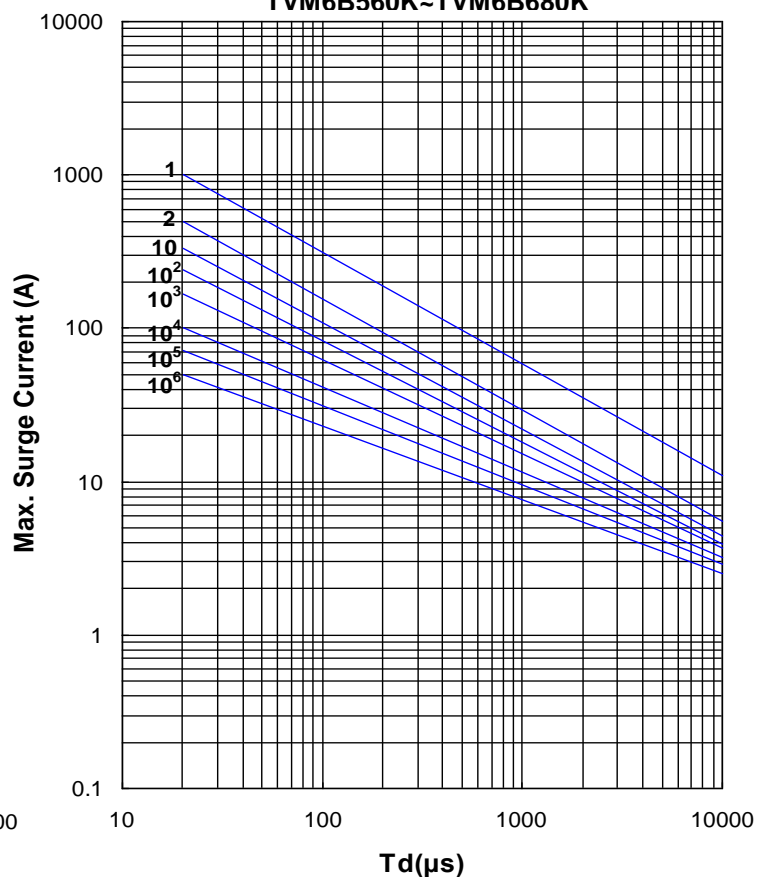

Metal Oxide Varistor : TVM-B Series



SMD Type Surge Suppressor

Max. Surge Current Derating Curves

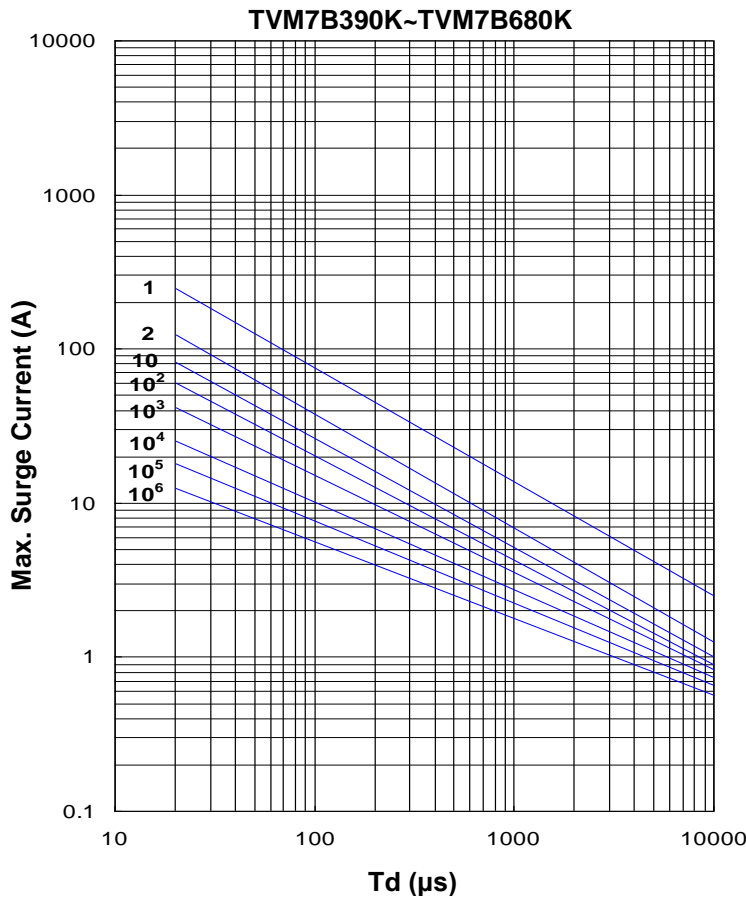
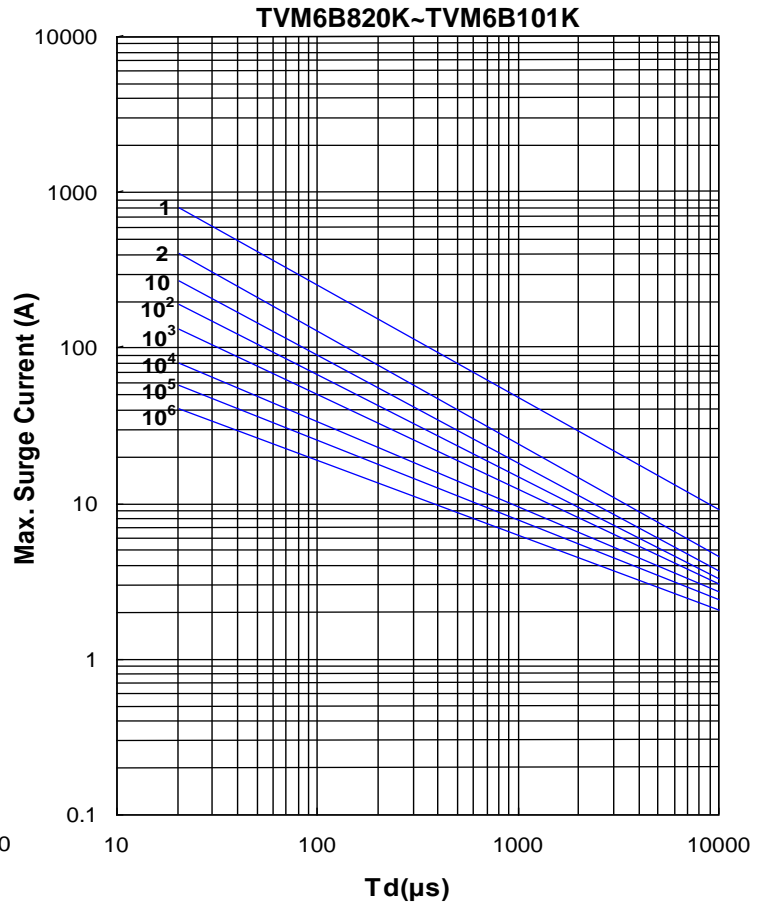
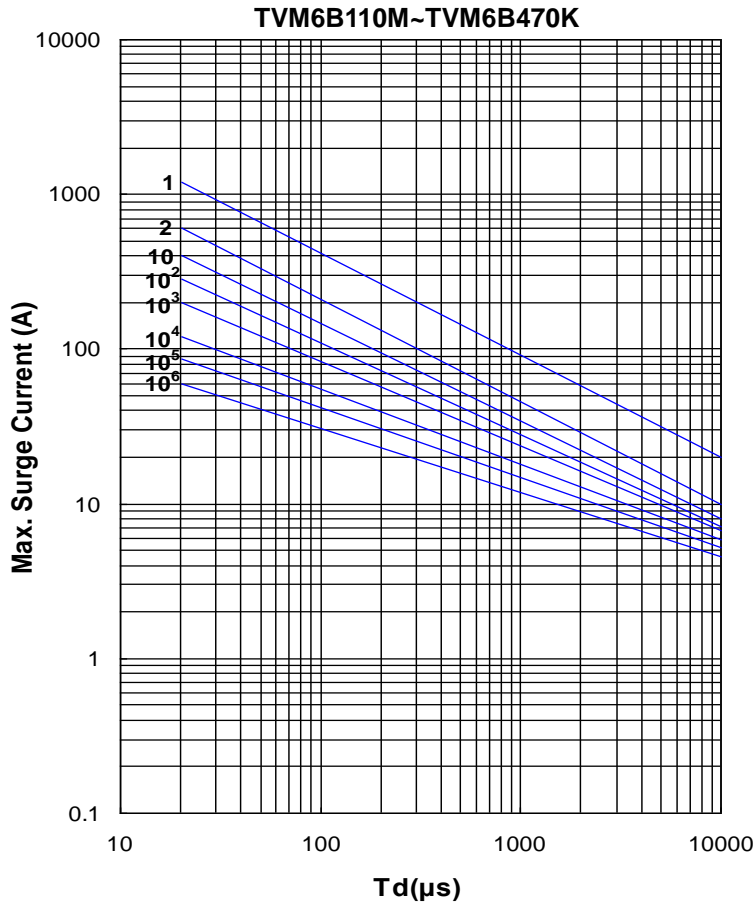

Metal Oxide Varistor : TVM-B Series

SMD Type Surge Suppressor



■ Max. Leakage Current and Max. Clamping Voltage Curves

Max. Leakage Current and Max. Clamping Voltage Curves (TVM0B080M~TVM0B330K)

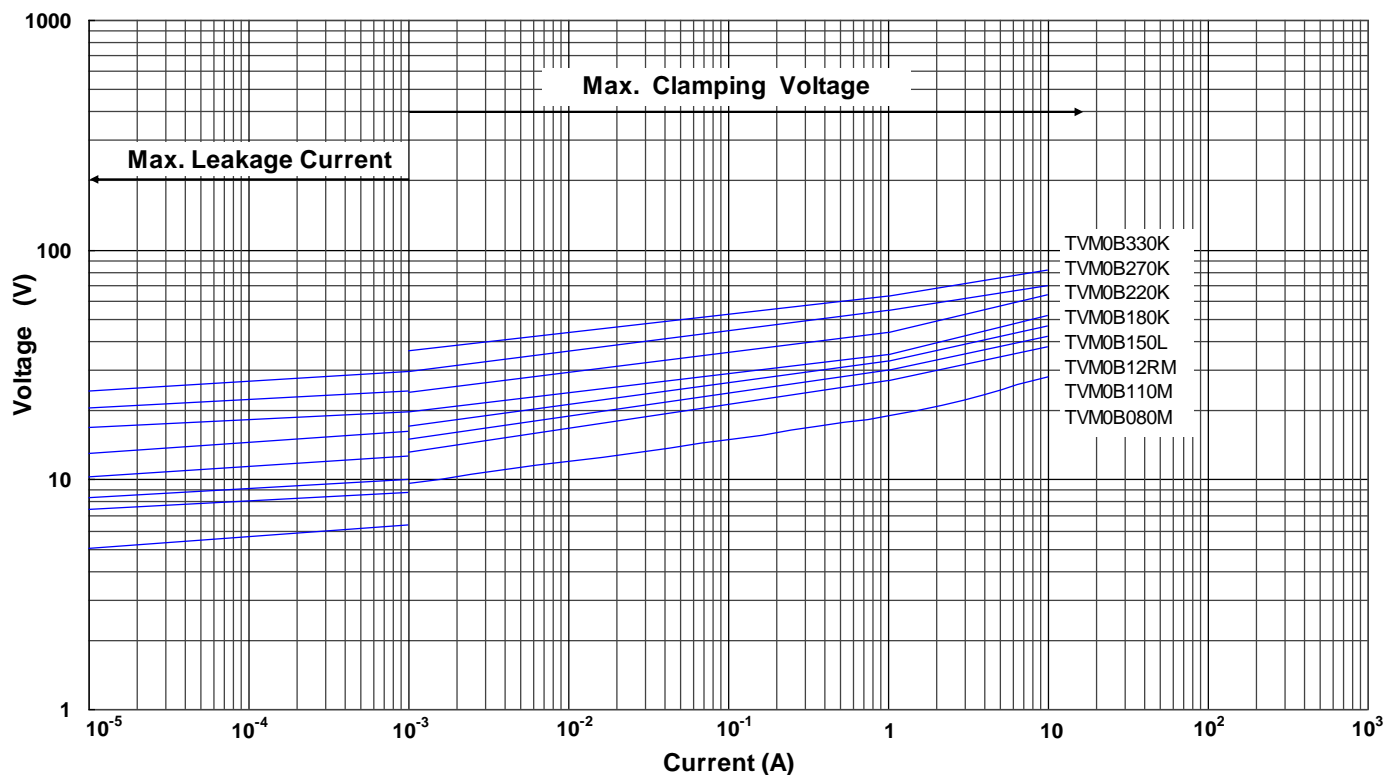

Max. Leakage Current and Max. Clamping Voltage Curves (TVM1B080M ~ TVM1B390K)

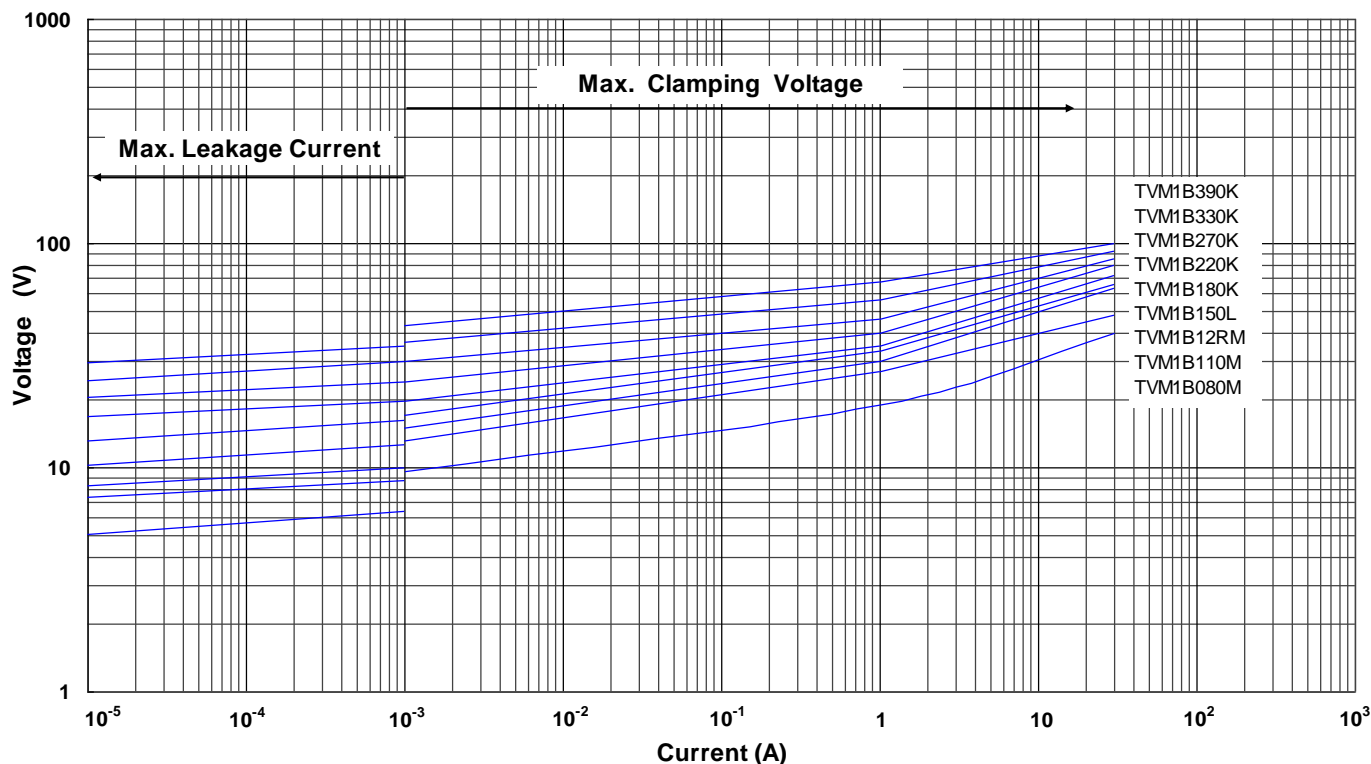

Metal Oxide Varistor : TVM-B Series

SMD Type Surge Suppressor



■ Max. Leakage Current and Max. Clamping Voltage Curves

Max. Leakage Current and Max. Clamping Voltage Curves (TVM2B080M ~ TVM2B560K)

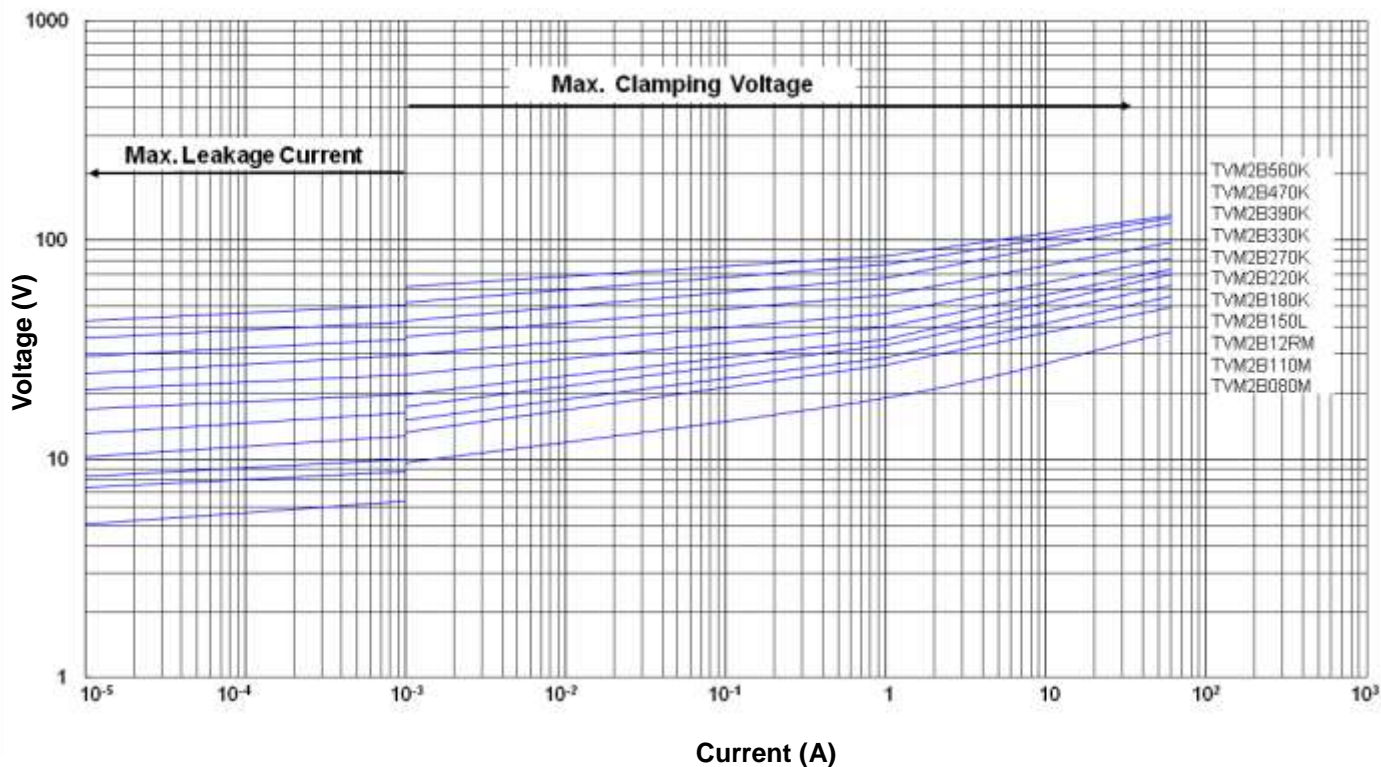

Max. Leakage Current and Max. Clamping Voltage Curves (TVM3B080M ~ TVM3B101K)

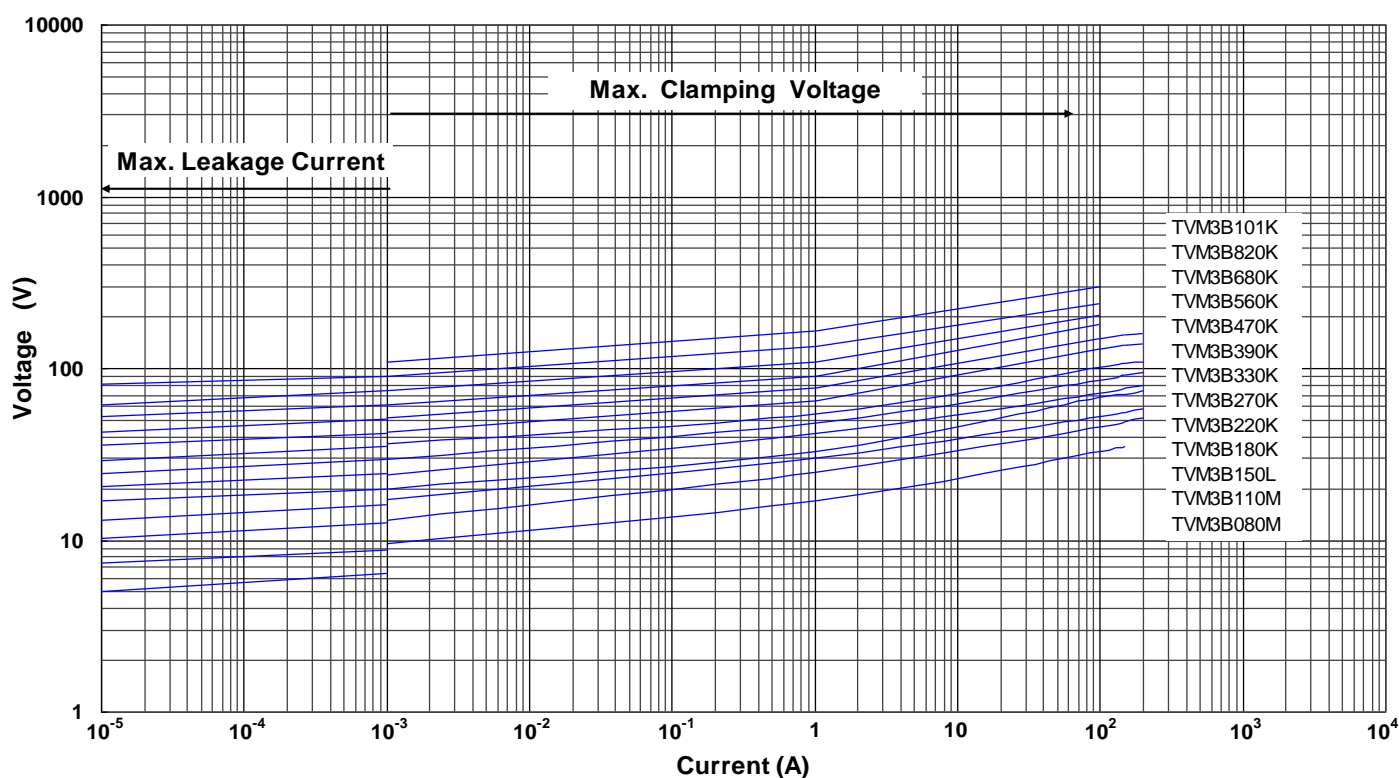

Metal Oxide Varistor : TVM-B Series

SMD Type Surge Suppressor



Max. Leakage Current and Max. Clamping Voltage Curves

Max. Leakage Current and Max. Clamping Voltage Curves (TVM4B080M ~ TVM4B101K)

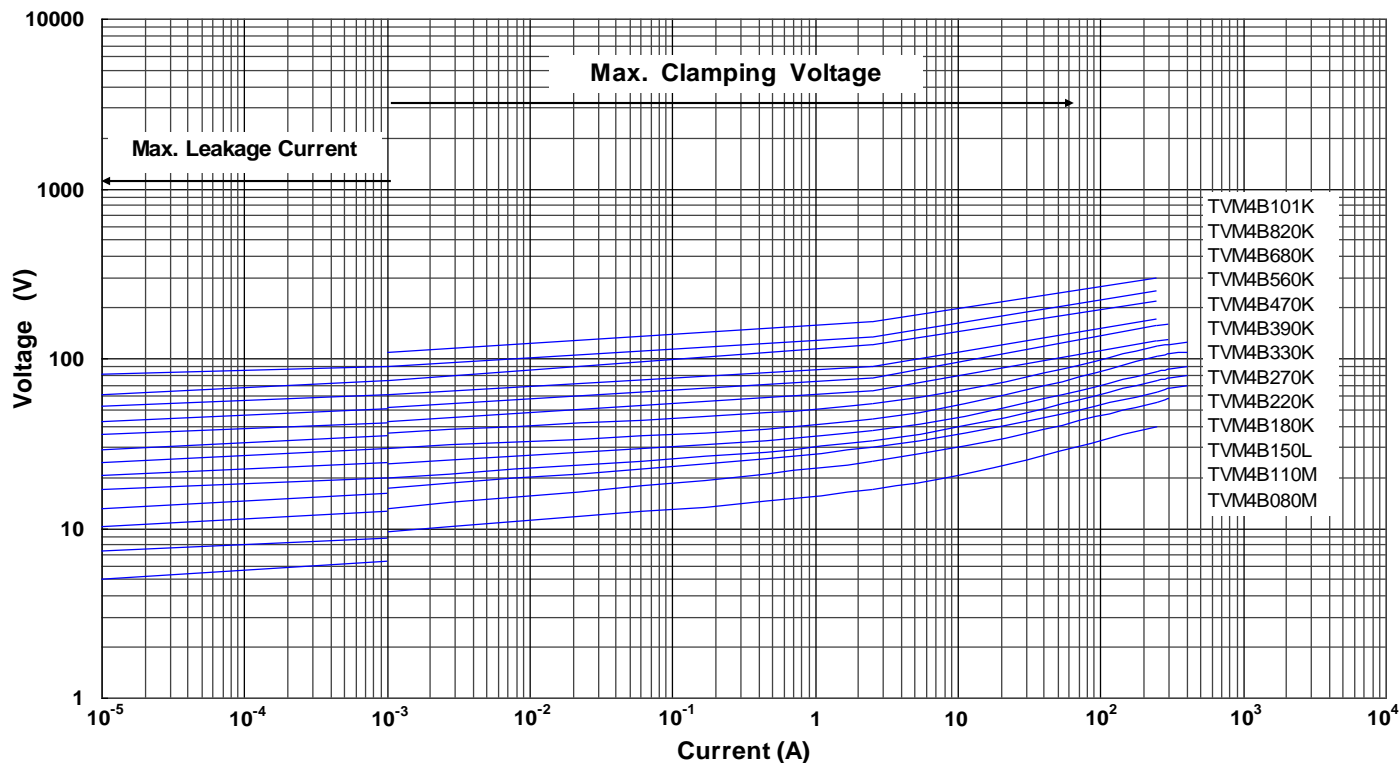

Max. Leakage Current and Max. Clamping Voltage Curves (TVM5B080M ~ TVM5B101K)

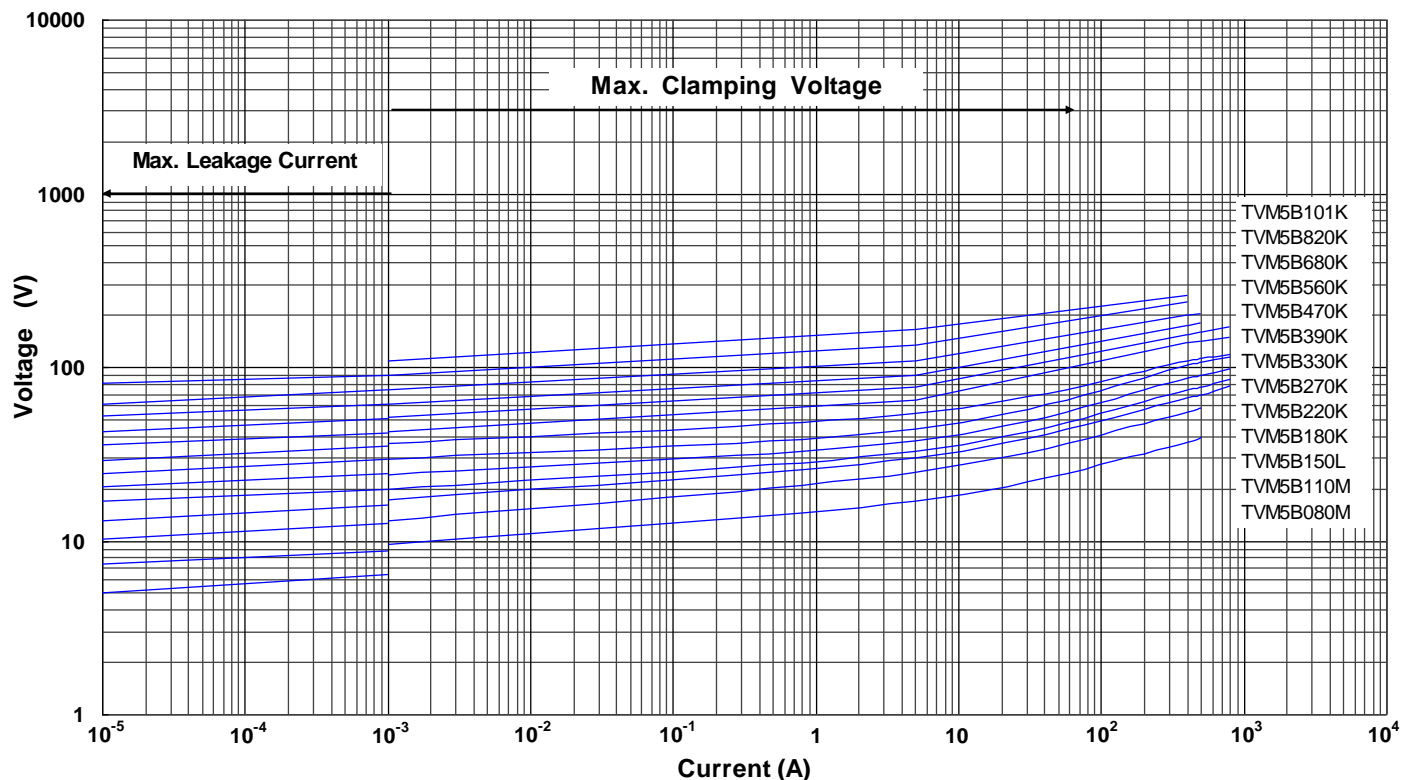

Metal Oxide Varistor : TVM-B Series

SMD Type Surge Suppressor



Max. Leakage Current and Max. Clamping Voltage Curves

Max. Leakage Current and Max. Clamping Voltage Curves (TVM6B080M ~ TVM6B101K)

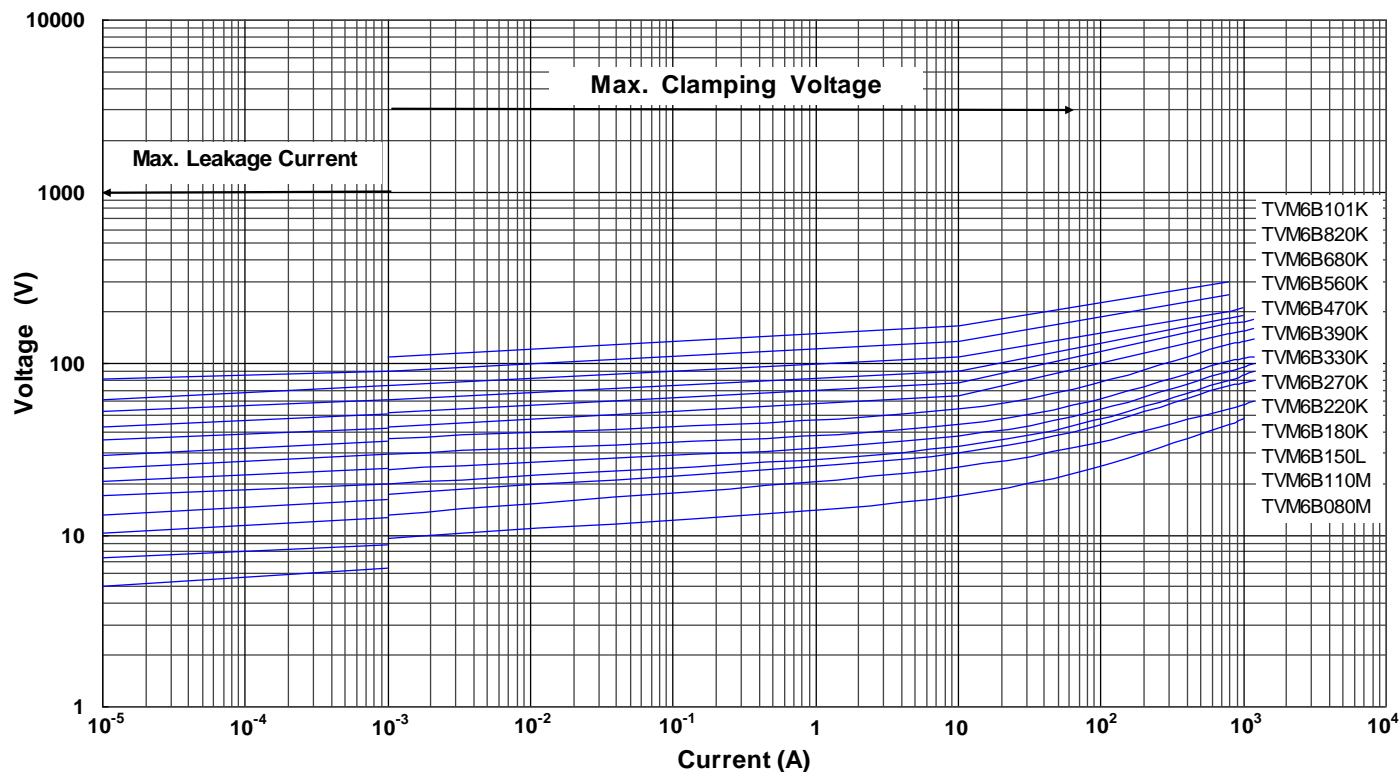

Max. Leakage Current and Max. Clamping Voltage Curves (TVM7B390M~TVM7B680K)

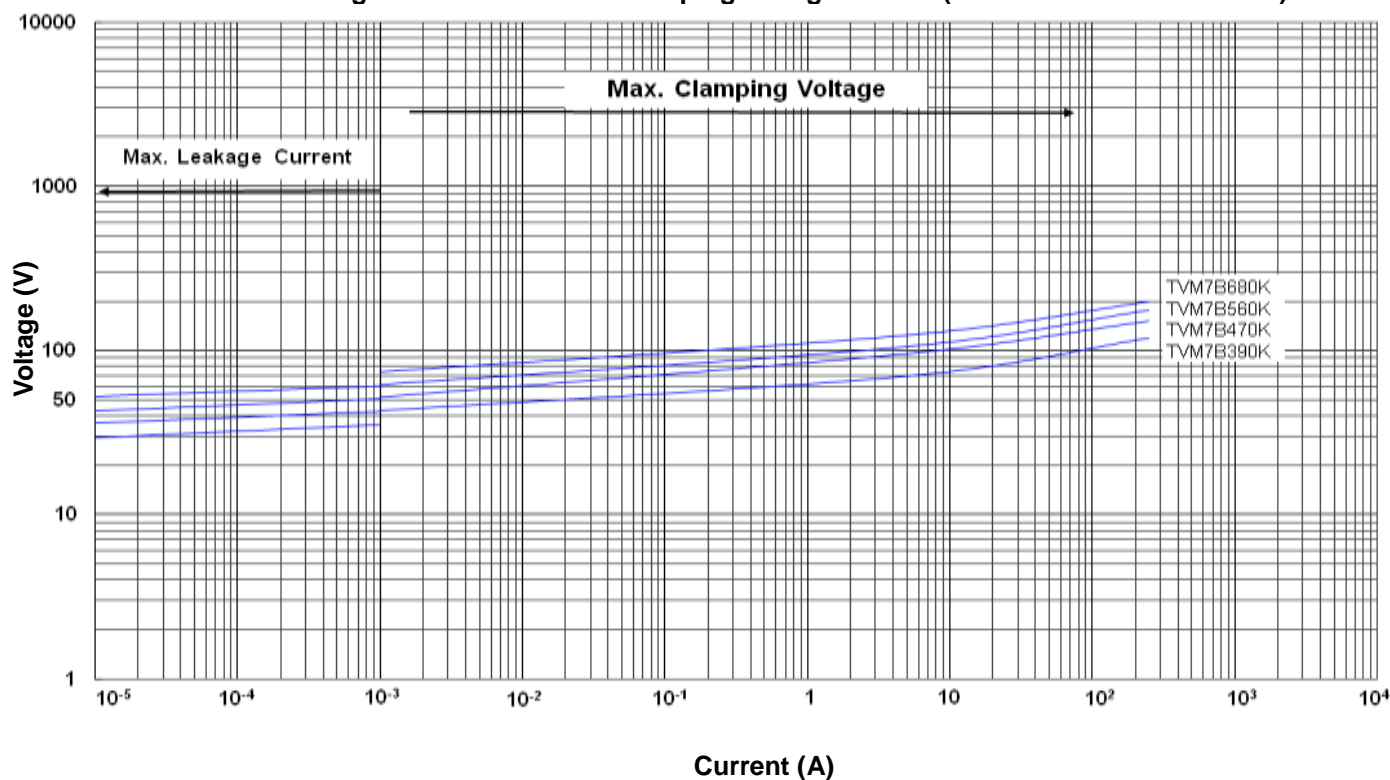

Metal Oxide Varistor : TVM-B Series

SMD Type Surge Suppressor



■ Soldering Recommendation

● IR-reflow Soldering Profile

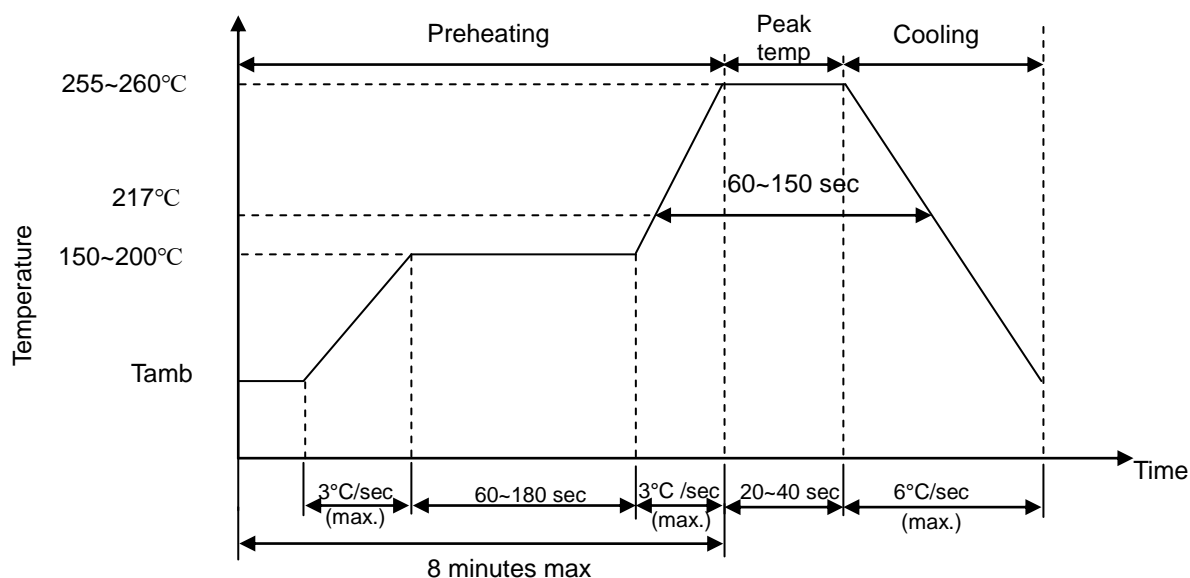

● Reworking Conditions with Soldering Iron

Item	Conditions
Temperature of Soldering Iron-tip	360°C (max.)
Soldering Time	3 sec (max.)
Diameter of Soldering Iron-tip	Φ 3mm (max.)
Caution: Not to touch the component surface with soldering iron directly to prevent component damage.	

■ Recommended Soldering Pad Dimensions

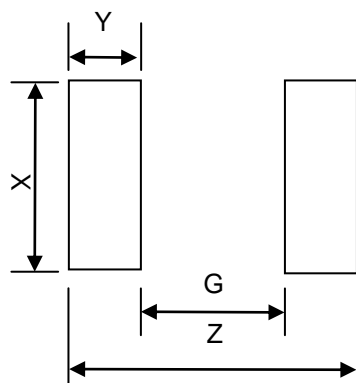

Size	Z (mm)	G (mm)	X (mm)	Y (mm)
0402	1.7	0.5	0.6	0.6
0603	3.0	1.0	1.0	1.0
0805	3.4	1.0	1.4	1.2
1206	4.5	2.1	1.8	1.2
1210	4.5	2.1	2.8	1.2
1812	6.0	3.0	3.6	1.5
2220	7.2	4.2	5.5	1.5
3025	9.0	6.0	5.5	1.5

Metal Oxide Varistor : TVM-B Series

SMD Type Surge Suppressor

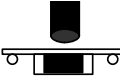
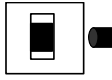

■ Reliability

Item	Standard	Test conditions / Methods	Specifications															
Bending Strength	IEC 60068-2-21	Warp: 2mm ; Speed<0.5mm/sec Duration: 10 sec on PCB 	$ \Delta V_{1mA} / V_{1mA} \leq 5\%$ No visible damage															
Adhesion	IEC 60068-2-21	Speed<0.5mm/sec on PCB 	$\geq 0.5\text{Kg}$ the terminal electrode shall be break off not the chip element															
Damp Heat Load, Steady State	IEC 60068-2-78	$40\pm 2^\circ\text{C}$ 90~95% RH 500 \pm 24 hrs at V_{DC}	$ \Delta V_{1mA} / V_{1mA} \leq 10\%$ No visible damage															
High Temp. Storage	IEC 60068-2-2	$125\pm 5^\circ\text{C}$ 1000 \pm 24 hrs	$ \Delta V_{1mA} / V_{1mA} \leq 5\%$ No visible damage															
Rapid Change of Temperature	IEC 60068-2-14	The conditions shown below shall be repeated 5 cycles on PCB. <table border="1" data-bbox="507 869 1189 1034"> <thead> <tr> <th>Step</th> <th>Temperature ($^\circ\text{C}$)</th> <th>Period (minutes)</th> </tr> </thead> <tbody> <tr> <td>1</td> <td>-40 ± 5</td> <td>30\pm3</td> </tr> <tr> <td>2</td> <td>Room temperature</td> <td>5\pm3</td> </tr> <tr> <td>3</td> <td>125 ± 5</td> <td>30\pm3</td> </tr> <tr> <td>4</td> <td>Room temperature</td> <td>5\pm3</td> </tr> </tbody> </table>	Step	Temperature ($^\circ\text{C}$)	Period (minutes)	1	-40 ± 5	30 \pm 3	2	Room temperature	5 \pm 3	3	125 ± 5	30 \pm 3	4	Room temperature	5 \pm 3	$ \Delta V_{1mA} / V_{1mA} \leq 5\%$ No visible damage
Step	Temperature ($^\circ\text{C}$)	Period (minutes)																
1	-40 ± 5	30 \pm 3																
2	Room temperature	5 \pm 3																
3	125 ± 5	30 \pm 3																
4	Room temperature	5 \pm 3																
High Temp. Load	MIL-STD-202 Method 108	$85\pm 2^\circ\text{C}$ 1000 \pm 24 hrs at V_{DC}	$ \Delta V_{1mA} / V_{1mA} \leq 5\%$ No visible damage															
Low Temp. Load	IEC 60068-2-1	$-40\pm 5^\circ\text{C}$ 1000 \pm 24 hrs at V_{DC}	$ \Delta V_{1mA} / V_{1mA} \leq 5\%$ No visible damage															
Max. Energy	IEC 61051-1	10/1000 μs Waveform, W_{max} , 1 surge current	$ \Delta V_{1mA} / V_{1mA} \leq 10\%$ No visible damage															
Max. Surge Current	IEC 61051-1	8/20 μs Waveform, I_{max} , 1 surge current	$ \Delta V_{1mA} / V_{1mA} \leq 10\%$ No visible damage															
Vibration	IEC 60068-2-6	Frequency range: 10~55Hz Amplitude: 0.75mm or 98m/s ² Direction: 3 mutually perpendicular directions, 2 hrs each	$ \Delta V_{1mA} / V_{1mA} \leq 5\%$ No visible damage															
Varistor Voltage Temp. Coefficient	Specification Standard	Measure V_{1mA} at -40°C , 25°C , 125°C	$ T_c \leq 0.05 (\%/^\circ\text{C})$															
Climatic Sequence	IEC 61051-1	a. 125°C x 16 hrs b. 1st cycle : 55°C 93%RH x 24 hrs c. -40°C x 2 hrs d. 5 cycles : 55°C 93%RH x 24 hrs/cycle	$ \Delta V_{1mA} / V_{1mA} \leq 10\%$ No visible damage															
Solderability	IEC 60068-2-58	$245\pm 5^\circ\text{C}$ 3 \pm 0.3 sec.	At least 95% of terminal electrode is covered by new solder															
Resistance to Soldering Heat	IEC 60068-2-58	$260\pm 5^\circ\text{C}$ 10 \pm 1 sec.	$ \Delta V_{1mA} / V_{1mA} \leq 5\%$ No visible damage															

Metal Oxide Varistor : TVM-B Series



SMD Type Surge Suppressor

■ Packaging

● Taping Specification

For 0402 Series

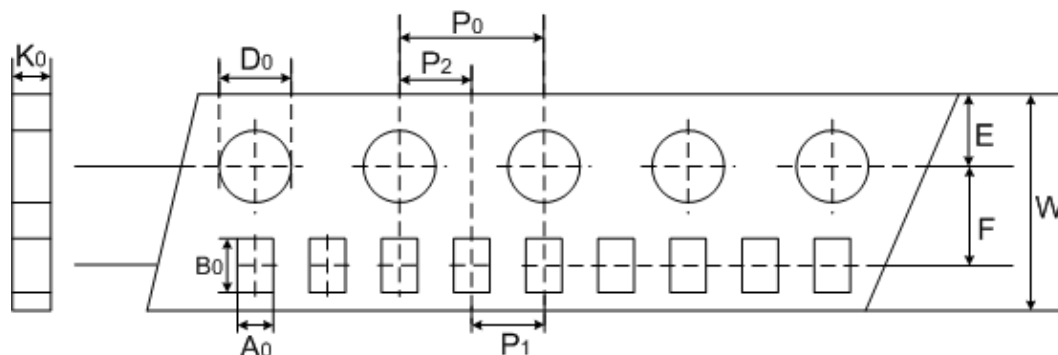

(Unit: mm)

Index Size	A_0 ± 0.05	B_0 ± 0.12	W ± 0.2	E ± 0.1	F ± 0.05	P_1 ± 0.1	P_2 ± 0.05	P_0 ± 0.1	D_0 ± 0.1	K_0 ± 0.1
0402	0.62	1.12	8	1.75	3.5	2	2	4	1.55	0.60

For 0603~0805 Series

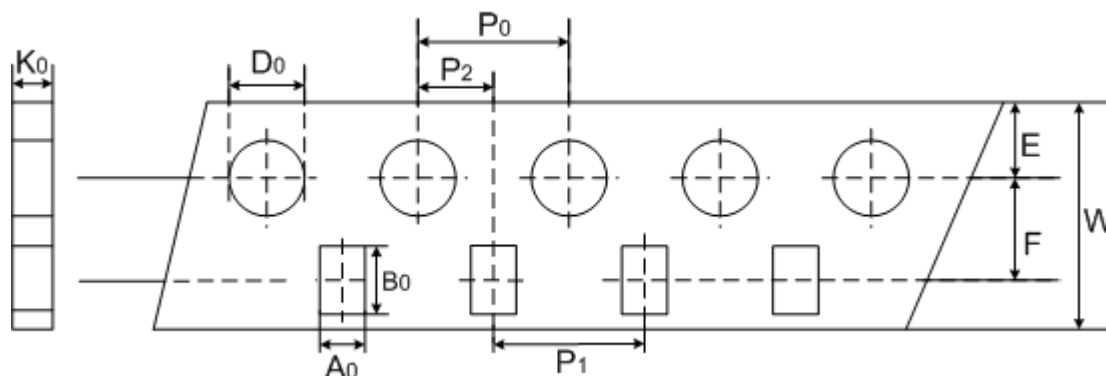

(Unit: mm)

Index Size	A_0 ± 0.2	B_0 ± 0.2	W ± 0.2	E ± 0.1	F ± 0.05	P_1 ± 0.1	P_2 ± 0.05	P_0 ± 0.1	D_0 ± 0.1	K_0 ± 0.1
0603	1.1	1.9	8	1.75	3.5	4	2	4	1.55	0.95
0805	1.5	2.3	8	1.75	3.5	4	2	4	1.55	1.00

Metal Oxide Varistor : TVM-B Series

SMD Type Surge Suppressor



For 1206~3025 Series

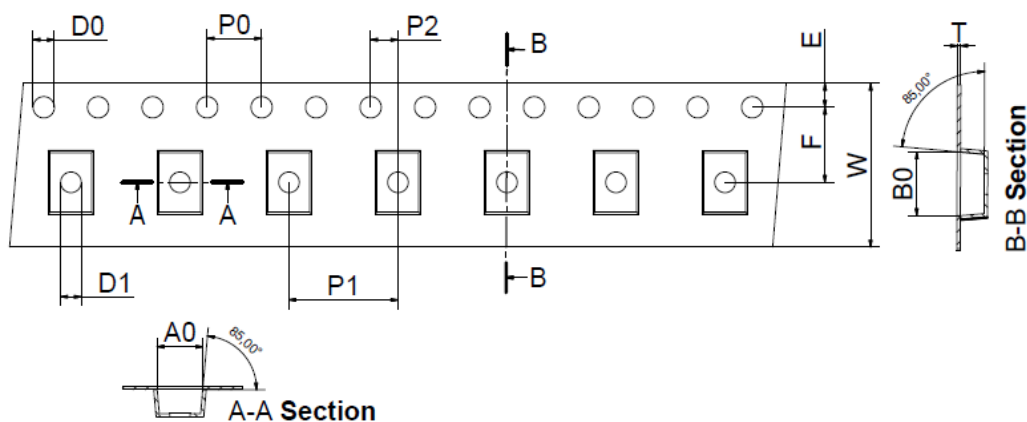

(Unit: mm)

Index Size	A ₀ ±0.2	B ₀ ±0.2	W ±0.2	E ±0.1	F ±0.05	P ₁ ±0.1	P ₂ ±0.05	P ₀ ±0.1	D ₀ ±0.1	D ₁ ±0.1	T ±0.1
1206	1.85	3.45	8	1.75	3.5	4	2	4	1.55	1	0.25
1210	2.75	3.55	8	1.75	3.5	4	2	4	1.55	1	0.25

Index Size	A ₀ ±0.2	B ₀ ±0.2	W ±0.3	E ±0.1	F ±0.05	P ₁ ±0.1	P ₂ ±0.05	P ₀ ±0.1	D ₀ ±0.1	D ₁ ±0.1	T ±0.1
1812	3.65	4.96	12	1.75	5.5	8	2	4	1.55	1.5	0.25
2220	5.50	6.25	12	1.75	5.5	8	2	4	1.55	1.5	0.25
3025	6.75	8.30	16	1.75	7.5	8	2	4	1.55	1.6	0.30

- Quantity

For 0402~1210 Series

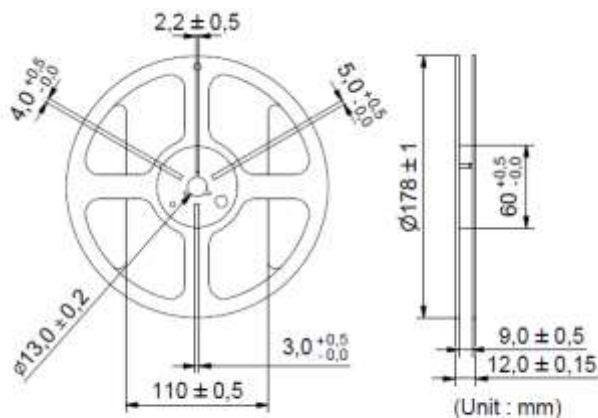

Size (EIA)	Quantity (pcs/reel)
0402	10,000
0603	4,000
0805	3,500
1206	2,500
1210	2,500