

# Metal Oxide Varistor for Automotive: TVM-C Series

## SMD Type for Transient Overvoltage Protection



### ■ Features

1. Qualification based on AEC-Q200 Rev-C
2. High surge suppression capability for automotive application (load dump)
3. No temperature derating up to 125 °C
4. Bidirectional and symmetrical V/I characteristics
5. Stability in high-temperature and high-humidity environment
6. RoHS & Halogen Free (HF) compliant



### ■ Recommended Applications

Transient overvoltage protection in automotive applications: engine management, airbag, control units, electro hydraulic brake, ABS/ESP, sunroof

### ■ Part Number Code

1	2	3	4	5	6	7	8	9	10	11	12	13	14	15	16
<b>Product Type</b>		<b>Size(EIA)</b>		<b>Max. Continuous Voltage(V<sub>DC</sub>)</b>		<b>Typical Capacitance</b>		<b>Packaging</b>		<b>Optional Suffix</b>					
TVM	THINKING SMD Varistor TVM Series	0	0402	5R5	5.5V	M330	33x10 <sup>0</sup> pF=33pF (@1MHz)	R	Reel	001 ~ZZZ					
		1	0603	090	9x10 <sup>0</sup> =9V	K102	10x10 <sup>2</sup> pF=1000pF (@1KHz)	B	Bulk						
		2	0805	330	33x10 <sup>0</sup> =33V										
		3	1206	<b>Series</b>											
		4	1210	C	Automotive Series										
		5	1812												
		6	2220												

### ■ Structures and Dimensions

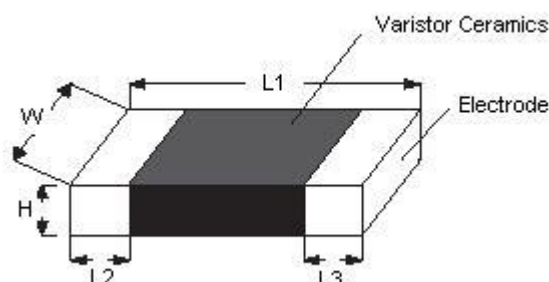

(Unit: mm)

Part No.	Size (EIA)	L1	W	H max.	L2 and L3
TVM0	0402	1.00±0.15	0.50±0.10	0.60	0.20±0.10
TVM1	0603	1.60 ±0.15	0.80±0.15	0.95	0.35±0.15
TVM2	0805	2.00 ±0.20	1.25±0.20	1.20	0.40±0.20
TVM3	1206	3.20 ±0.30	1.60±0.20	1.50	0.50±0.20
TVM4	1210	3.20 ±0.30	2.50±0.25	1.50	0.50±0.20
TVM5	1812	4.50 ±0.40	3.20±0.30	2.00	0.60±0.30
TVM6	2220	5.70±0.40	5.00±0.30	2.50	0.60±0.30

# Metal Oxide Varistor for Automotive: TVM-C Series

## SMD Type for Transient Overvoltage Protection



### ■ Electrical Characteristics

#### ● 0402 Series

Part No.	Varistor Voltage	Max. Continuous Voltage		Max. Clamping Voltage (8/20 $\mu$ s)		Max. Surge Current (8/20 $\mu$ s)	Max. Energy (10/1000 $\mu$ s)	Typical Capacitance		Operating Temp. Range
	V <sub>1mA</sub>	V <sub>AC</sub>	V <sub>DC</sub>	V <sub>P</sub>	I <sub>P</sub>	I <sub>max</sub>	W <sub>max</sub>	1KHz	1MHz	(°C)
	(V)	(V)	(V)	(V)	(A)	(A)	(J)	(pF)	(pF)	
TVM0C140K800R	16~21	11	14	35	1	10	0.05	80 $\pm$ 30%	--	-55~+125
TVM0C180M120R	22~28	14	18	55	1	2	0.03	--	12 $\pm$ 30%	
TVM0C180M400R	22~28	14	18	50	1	20	0.05	--	40 $\pm$ 30%	
TVM0C180M500R	22~28	14	18	50	1	20	0.05	--	50 $\pm$ 30%	
TVM0C180M600R	22~28	14	18	50	1	20	0.05	--	60 $\pm$ 30%	
TVM0C180M650R	22~28	14	18	50	1	20	0.05	--	65 $\pm$ 30%	

#### ● 0603 Series

Part No.	Varistor Voltage	Max. Continuous Voltage		Max. Clamping Voltage (8/20 $\mu$ s)		Max. Surge Current (8/20 $\mu$ s)	Max. Energy (10/1000 $\mu$ s)	Typical Capacitance		Operating Temp. Range
	V <sub>1mA</sub>	V <sub>AC</sub>	V <sub>DC</sub>	V <sub>P</sub>	I <sub>P</sub>	I <sub>max</sub>	W <sub>max</sub>	1KHz	1MHz	(°C)
	(V)	(V)	(V)	(V)	(A)	(A)	(J)	(pF)	(pF)	
TVM1C090M491R	11~16	7	9	29	1	30	0.1	--	490 $\pm$ 30%	-55~+125
TVM1C160K561R	21.6~26.4	12	16	45	1	30	0.1	560 $\pm$ 30%	--	
TVM1C180K300R	23~30	14	18	52	1	4	0.03	30 $\pm$ 30%	--	
TVM1C180M300R	23~30	14	18	52	1	4	0.03	--	30 $\pm$ 30%	
TVM1C180M900R	23~30	14	18	48	1	30	0.1	--	90 $\pm$ 30%	
TVM1C180K101R	23~30	14	18	48	1	30	0.1	100 $\pm$ 30%	--	
TVM1C180K431R	23~30	14	18	45	1	50	0.1	430 $\pm$ 30%	--	
TVM1C220K530R	25~40	17	22	50	1	30	0.1	53 $\pm$ 30%	--	
TVM1C220K101R	25~33	17	22	50	1	30	0.1	100 $\pm$ 30%	--	
TVM1C260M111R	31~38	20	26	60	1	30	0.1	--	110 $\pm$ 30%	
TVM1C310K900R	35.1~42.9	25	31	67	1	30	0.3	90 $\pm$ 30%	--	
TVM1C320M100R	51.9~70.1	25	32	120	1	5	0.05	--	10 $\pm$ 30%	

# Metal Oxide Varistor for Automotive: TVM-C Series

## SMD Type for Transient Overvoltage Protection



### ■ Electrical Characteristics

#### ● 0805 Series

Part No.	Varistor Voltage	Max. Continuous Voltage		Max. Clamping Voltage (8/20 $\mu$ s)		Max. Surge Current (8/20 $\mu$ s)	Max. Energy (10/1000 $\mu$ s)	Typical Capacitance	V <sub>jump</sub> (5min)	W <sub>LD</sub> (10x)	Operating Temp. Range
	V <sub>1mA</sub>	V <sub>AC</sub>	V <sub>DC</sub>	V <sub>P</sub>	I <sub>P</sub>	I <sub>max</sub>	W <sub>max</sub>	1KHz	(V)	(J)	(°C)
	(V)	(V)	(V)	(V)	(A)	(A)	(J)	(pF)			
TVM2C160K651R	21.6~26.4	12	16	40	1	120	0.3	650 $\pm$ 20%	24.5	1	-55~+125
TVM2C180K651R	23~28	14	18	44	1	120	0.3	650 $\pm$ 20%	24.5	1	
TVM2C180K751R	23~28	14	18	44	1	120	0.3	750 $\pm$ 20%	24.5	1	
TVM2C260K501R	29.7~36.3	20	26	56	1	80	0.3	500 $\pm$ 20%	27	1	
TVM2C310K251R	35.1~42.9	25	31	67	1	80	0.3	250 $\pm$ 20%	29	0.5	

#### ● 1206 Series

Part No.	Varistor Voltage	Max. Continuous Voltage		Max. Clamping Voltage (8/20 $\mu$ s)		Max. Surge Current (8/20 $\mu$ s)	Max. Energy (10/1000 $\mu$ s)	Typical Capacitance	V <sub>jump</sub> (5min)	W <sub>LD</sub> (10x)	Operating Temp. Range
	V <sub>1mA</sub>	V <sub>AC</sub>	V <sub>DC</sub>	V <sub>P</sub>	I <sub>P</sub>	I <sub>max</sub>	W <sub>max</sub>	1KHz	(V)	(J)	(°C)
	(V)	(V)	(V)	(V)	(A)	(A)	(J)	(pF)			
TVM3C160K102R	21.6~26.4	12	16	40	1	200	0.6	1000 $\pm$ 20%	24.5	1.5	-55~+125
TVM3C160K242R	21.6~26.4	12	16	38	1	400	0.6	2400 $\pm$ 20%	24.5	2	
TVM3C180K102R	22.95~28.05	14	18	42	1	150	0.6	1000 $\pm$ 20%	24.5	1.5	
TVM3C260K801R	29.7~36.3	20	26	54	1	200	0.7	800 $\pm$ 20%	27.5	1.2	
TVM3C260K132R	29.7~36.3	20	26	54	1	250	0.7	1300 $\pm$ 20%	27.5	1.5	
TVM3C340K551R	42.3~51.7	26	34	77	1	200	0.4	550 $\pm$ 20%	50	1.5	
TVM3C450K301R	50.4~61.6	35	45	90	1	100	0.4	300 $\pm$ 20%	59	1.2	
TVM3C480K271R	55.8~68.2	37	48	100	1	100	0.4	270 $\pm$ 20%	59	1.2	
TVM3C560K251R	61.2~74.8	40	56	110	1	100	0.5	250 $\pm$ 20%	65	1.5	

# Metal Oxide Varistor for Automotive: TVM-C Series

## SMD Type for Transient Overvoltage Protection



### ■ Electrical Characteristics

#### ● 1210 Series

Part No.	Varistor Voltage	Max. Continuous Voltage		Max. Clamping Voltage (8/20 $\mu$ s)		Max. Surge Current (8/20 $\mu$ s)	Max. Energy (10/1000 $\mu$ s)	Typical Capacitance	V <sub>jump</sub> (5min)	W <sub>LD</sub> (10x)	Operating Temp. Range
	V <sub>1mA</sub>	V <sub>AC</sub>	V <sub>DC</sub>	V <sub>P</sub>	I <sub>P</sub>	I <sub>max</sub>	W <sub>max</sub>	1KHz	(V)	(J)	(°C)
	(V)	(V)	(V)	(V)	(A)	(A)	(J)	(pF)			
TVM4C160K242R	21.6~26.4	12	16	40	2.5	400	1.6	2400 $\pm$ 20%	24.5	3	-55~+125
TVM4C180K312R	22.95~28.05	14	18	42	2.5	500	1.6	3100 $\pm$ 20%	27.5	3	
TVM4C260K152R	29.7~36.3	20	26	54	2.5	400	1.9	1500 $\pm$ 20%	27	3	
TVM4C310K122R	35.1~42.9	25	31	65	2.5	300	1.7	1200 $\pm$ 20%	29	3	
TVM4C340K112R	42.3~51.7	26	34	75	2.5	300	2.3	1100 $\pm$ 20%	50	3	
TVM4C450K601R	50.4~61.6	35	45	90	2.5	250	2	600 $\pm$ 20%	60	1.5	

#### ● 1812 Series

Part No.	Varistor Voltage	Max. Continuous Voltage		Max. Clamping Voltage (8/20 $\mu$ s)		Max. Surge Current (8/20 $\mu$ s)	Max. Energy (10/1000 $\mu$ s)	Typical Capacitance	V <sub>jump</sub> (5min)	W <sub>LD</sub> (10x)	Operating Temp. Range
	V <sub>1mA</sub>	V <sub>AC</sub>	V <sub>DC</sub>	V <sub>P</sub>	I <sub>P</sub>	I <sub>max</sub>	W <sub>max</sub>	1KHz	(V)	(J)	(°C)
	(V)	(V)	(V)	(V)	(A)	(A)	(J)	(pF)			
TVM5C160K452R	21.6~26.4	12	16	40	5	800	2.4	4500 $\pm$ 20%	24.5	6	-55~+125
TVM5C260K322R	29.7~36.3	20	26	54	5	800	3	3200 $\pm$ 20%	30	6	
TVM5C300K172R	35~43	23	30	77	5	600	3.8	1700 $\pm$ 20%	45	6	

#### ● 2220 Series

Part No.	Varistor Voltage	Max. Continuous Voltage		Max. Clamping Voltage (8/20 $\mu$ s)		Max. Surge Current (8/20 $\mu$ s)	Max. Energy (10/1000 $\mu$ s)	Typical Capacitance	V <sub>jump</sub> (5min)	W <sub>LD</sub> (10x)	Operating Temp. Range
	V <sub>1mA</sub>	V <sub>AC</sub>	V <sub>DC</sub>	V <sub>P</sub>	I <sub>P</sub>	I <sub>max</sub>	W <sub>max</sub>	1KHz	(V)	(J)	(°C)
	(V)	(V)	(V)	(V)	(A)	(A)	(J)	(pF)			
TVM6C160K103R	21.6~26.4	12	16	42	10	1200	5.8	10000 $\pm$ 20%	24.5	12	-55~+125
TVM6C160K203R	21.6~26.4	12	16	42	10	1200	10	20000 $\pm$ 20%	24.5	25	
TVM6C340K652R	42.3~51.7	26	34	77	10	1200	12	6500 $\pm$ 20%	50	12	
TVM6C380K302R	42.3~51.7	30	38	77	10	1000	12	3000 $\pm$ 20%	50	12	

# Metal Oxide Varistor for Automotive: TVM-C Series

## SMD Type for Transient Overvoltage Protection



### ■ Power Derating Curve

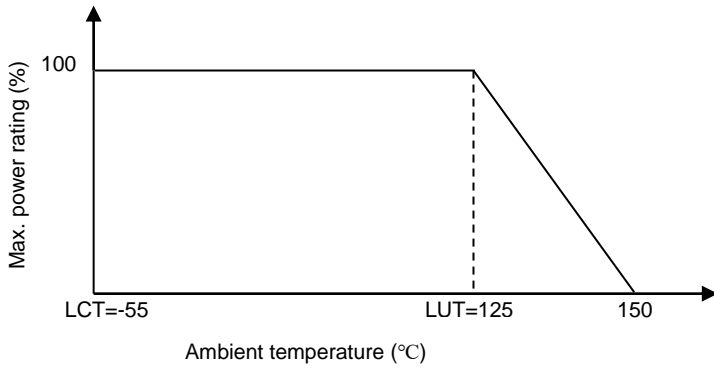

### ■ Surge Current Standard Waveform

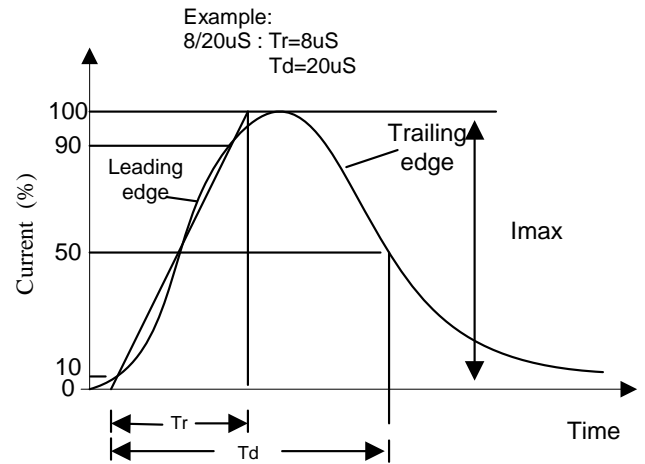

### ■ Max. Surge Current Derating Curves

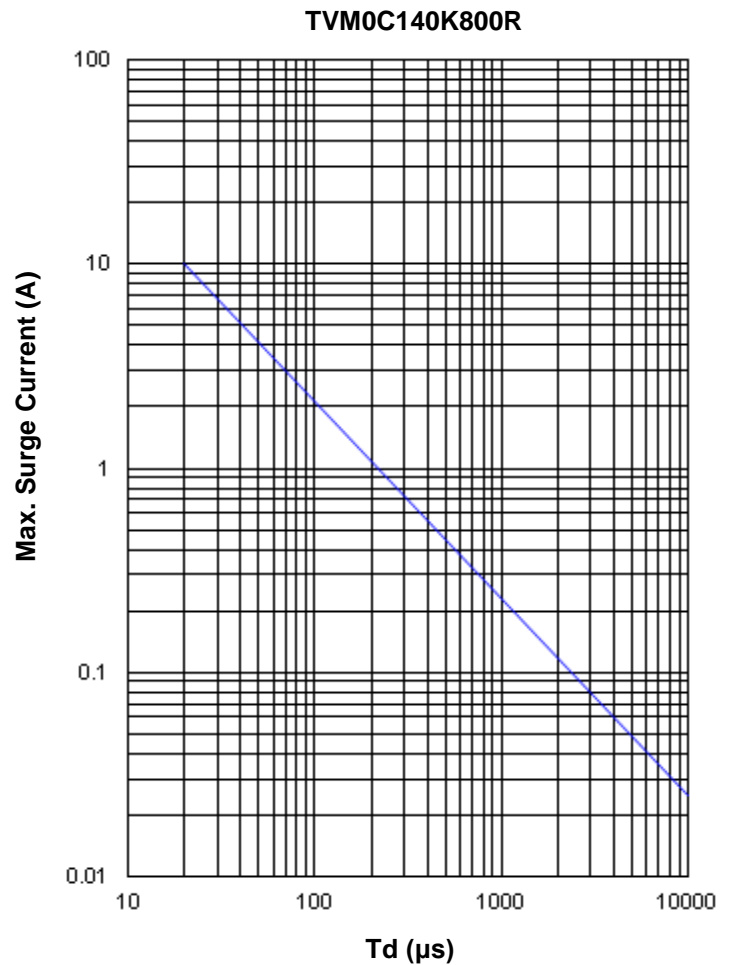
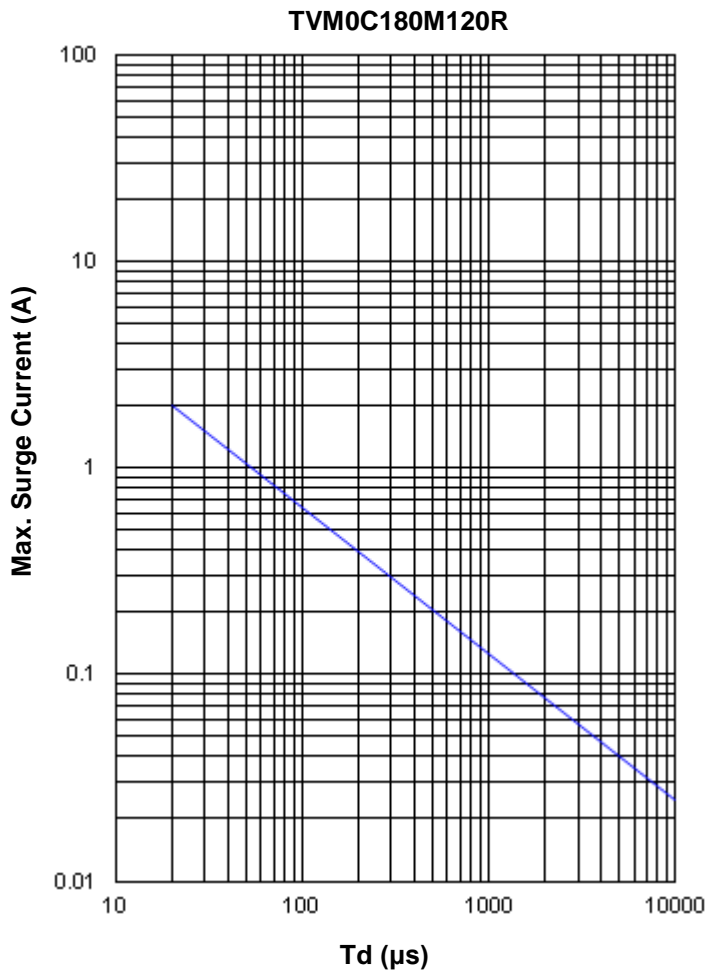

# Metal Oxide Varistor for Automotive: TVM-C Series

## SMD Type for Transient Overvoltage Protection



### Max. Surge Current Derating Curves

TVM0C180M400R~TVM0C180M650R

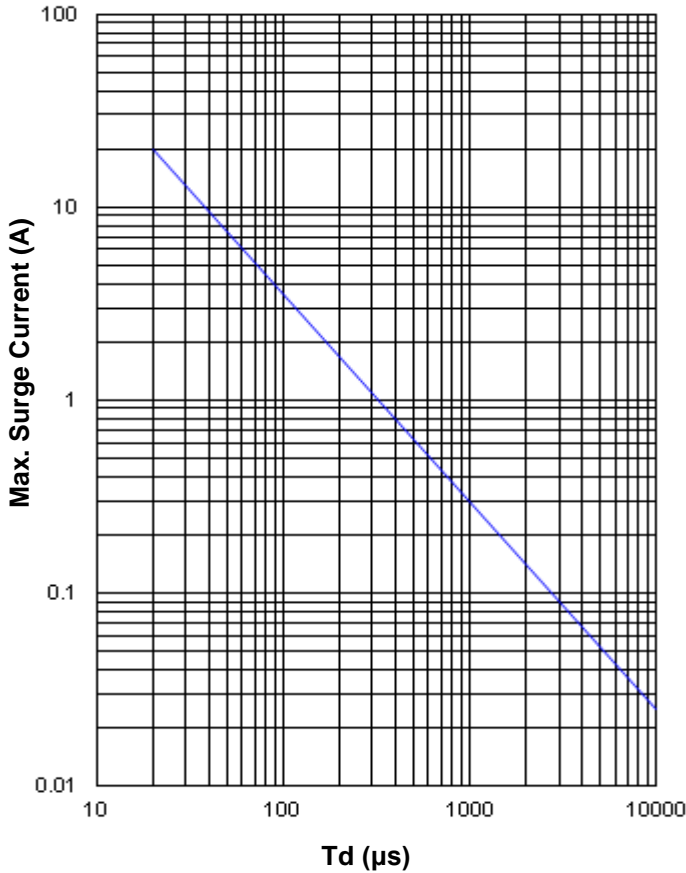

TVM1C180K300R/TVM1C180M300R

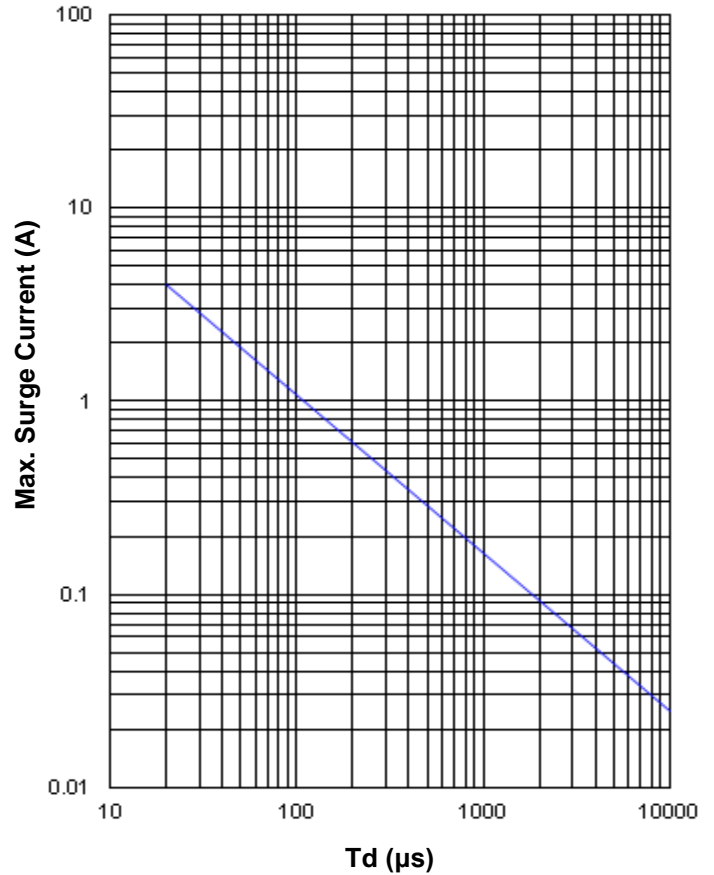

TVM1C320M100R

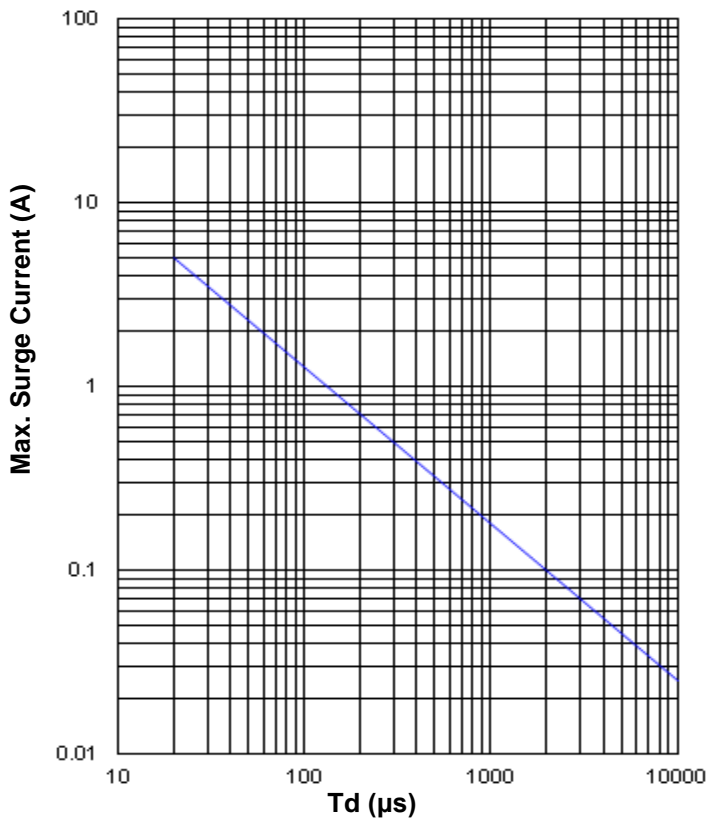

TVM1C180K431R

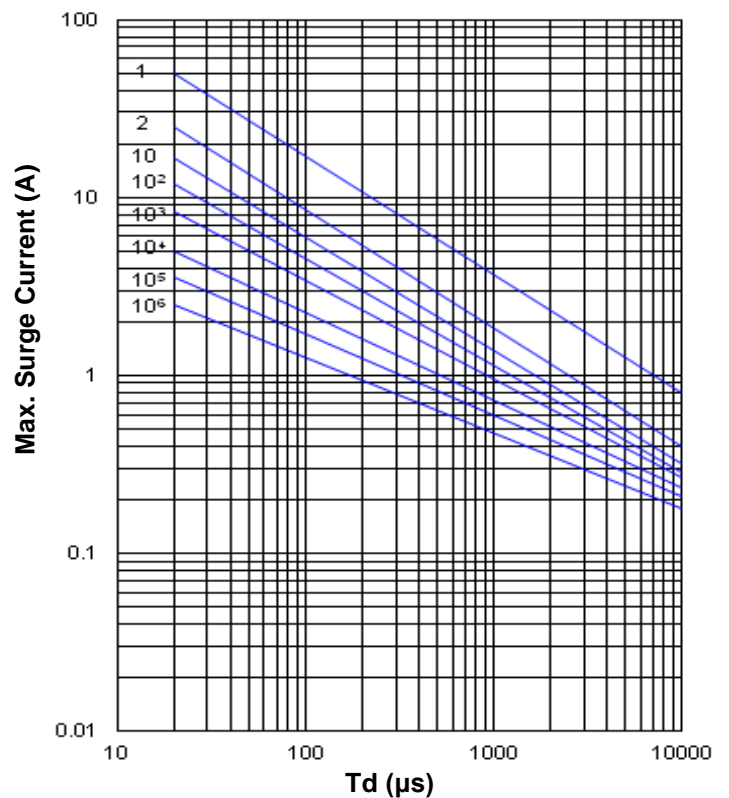

# Metal Oxide Varistor for Automotive: TVM-C Series

## SMD Type for Transient Overvoltage Protection



### Max. Surge Current Derating Curves

TVM1C090M491R/TVM1C160K561R/  
 TVM1C180M900R/TVM1C180K101R/  
 TVM1C220K530R/TVM1C220K101R/  
 TVM1C260M111R/TVM1C310K900R

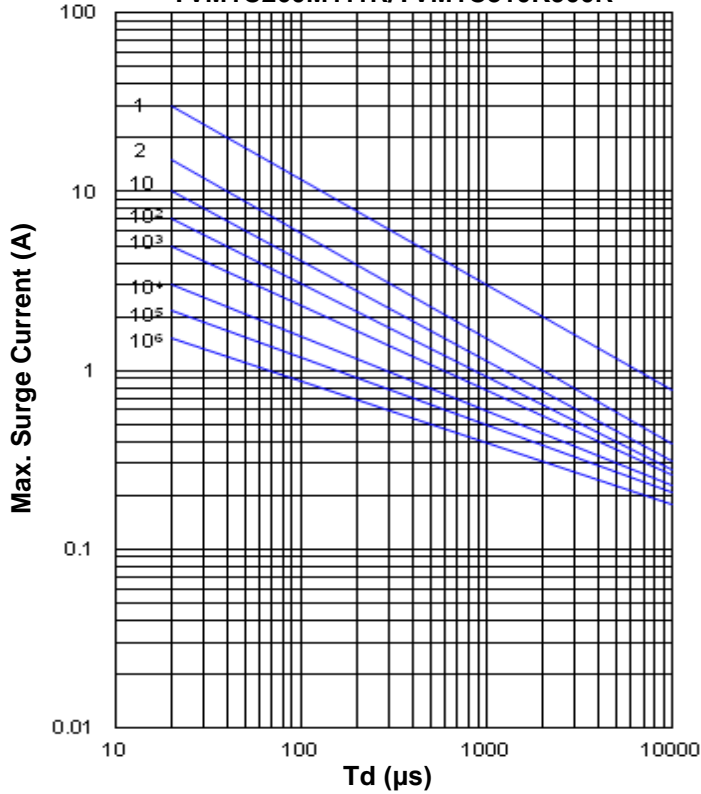

TVM2C260K501R  
 TVM2C310K251R

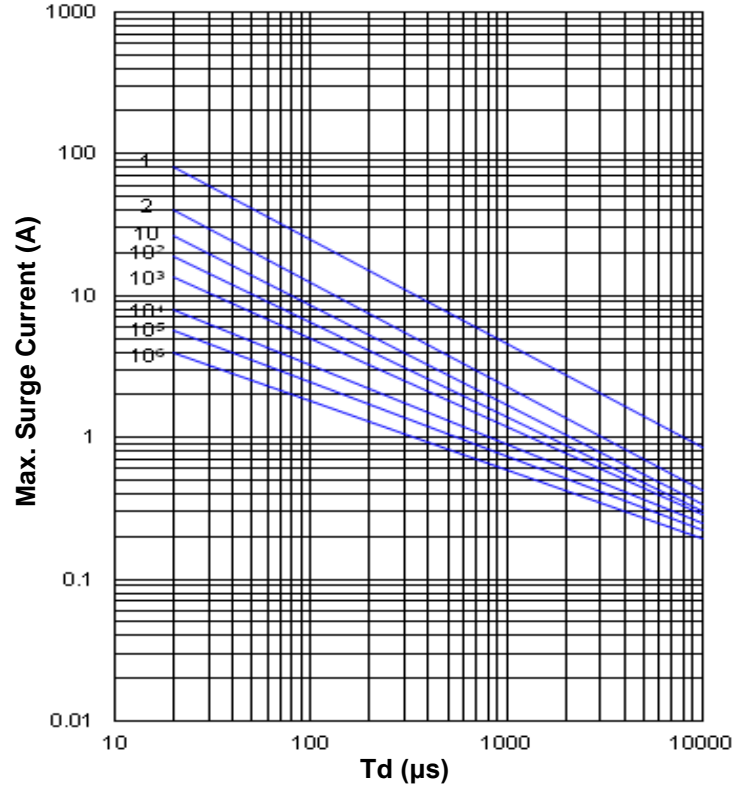

TVM2C160K651R  
 TVM2C180K651R / TVM2C180K751R

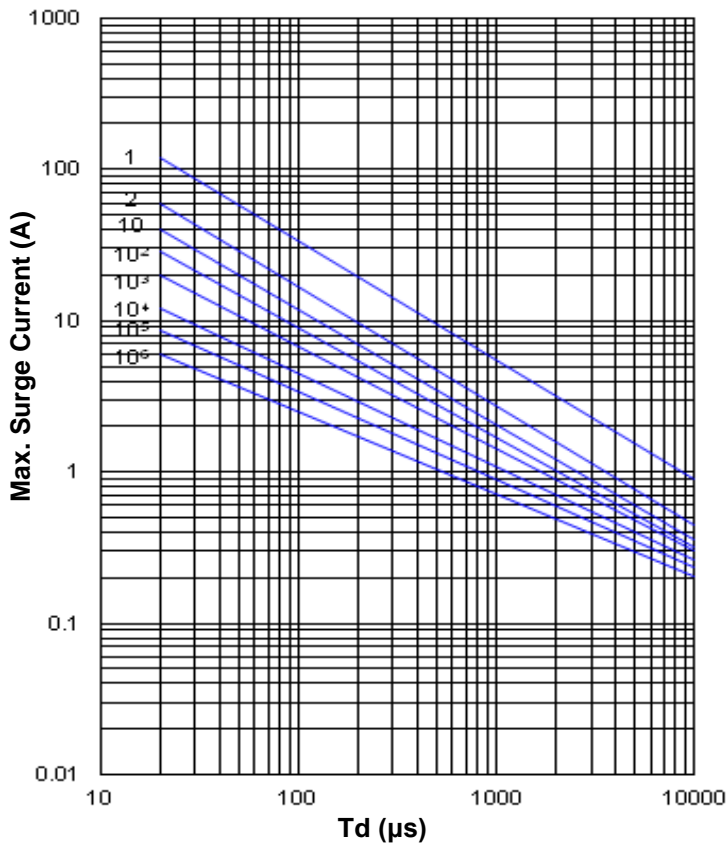

TVM3C450K301R/TVM3C480K271R/  
 TVM3C560K251R

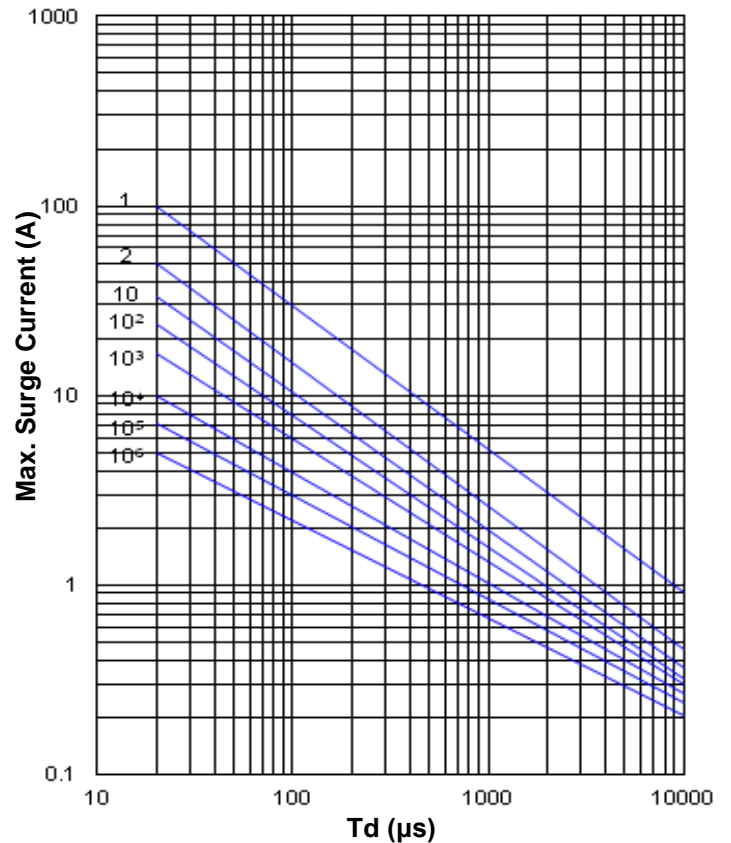

# Metal Oxide Varistor for Automotive: TVM-C Series

## SMD Type for Transient Overvoltage Protection



### Max. Surge Current Derating Curves

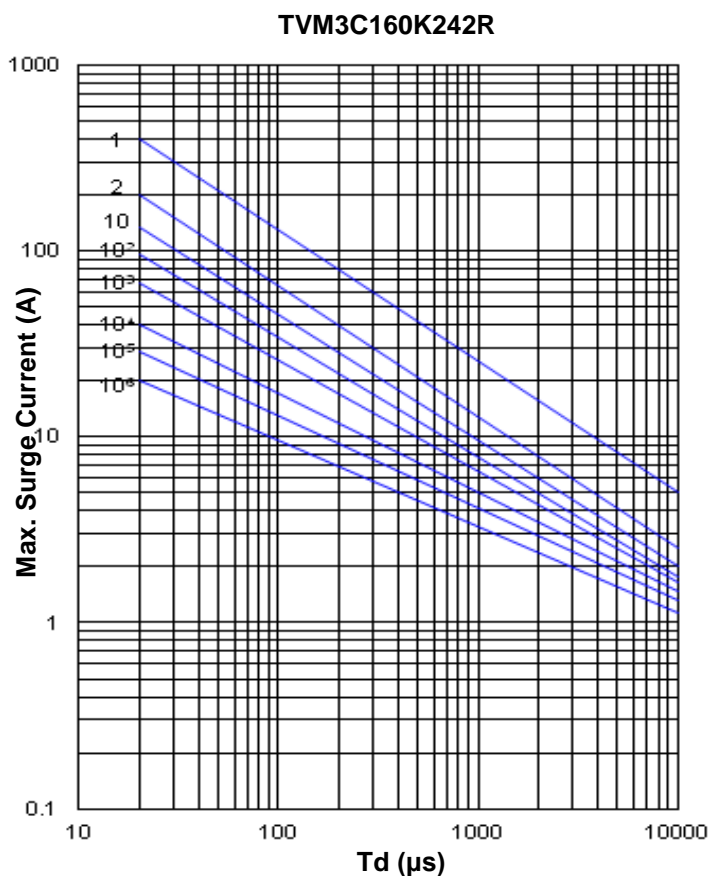
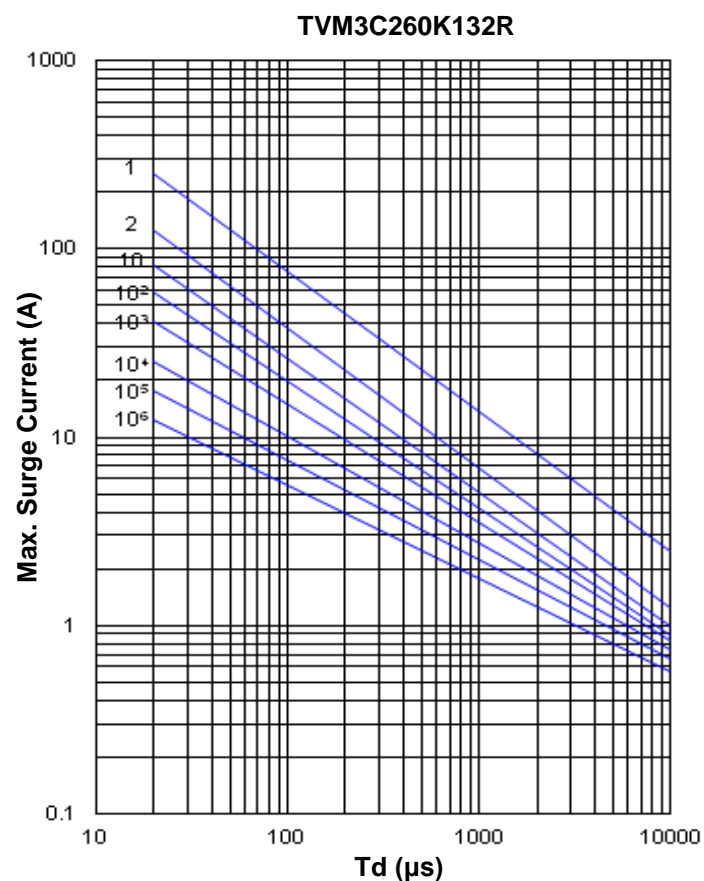
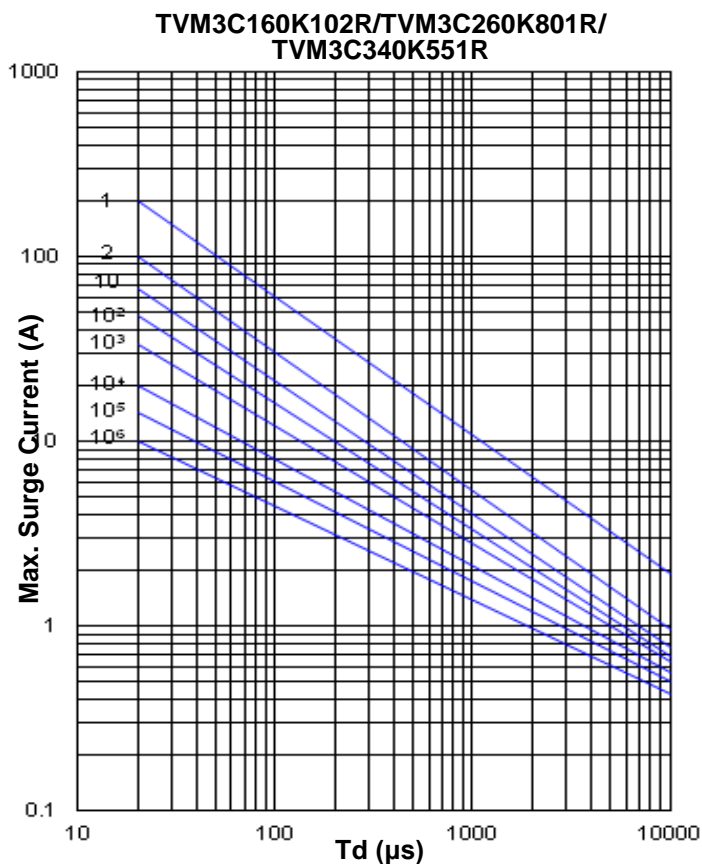
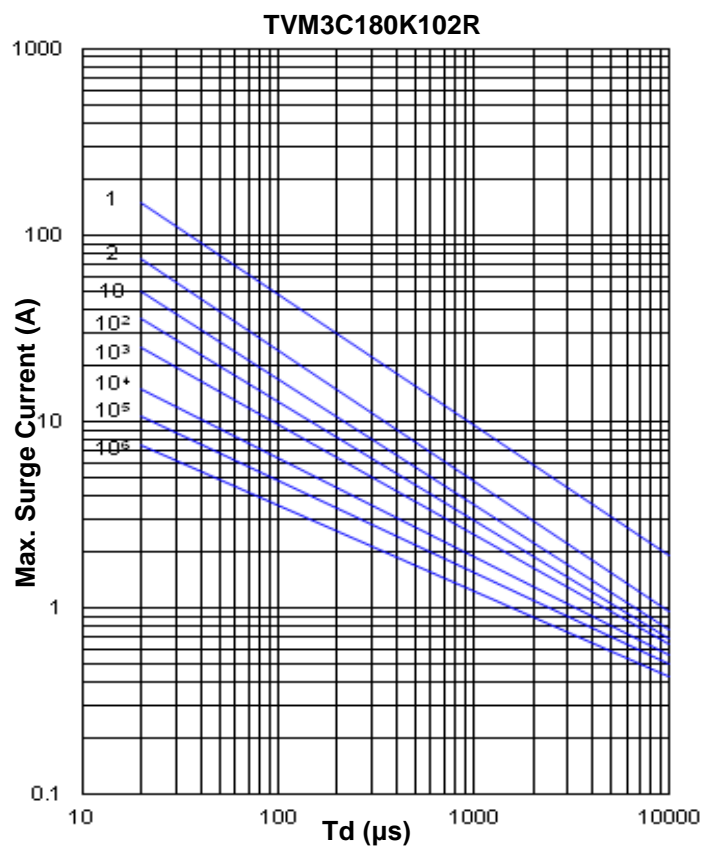



# Metal Oxide Varistor for Automotive: TVM-C Series

## SMD Type for Transient Overvoltage Protection



### Max. Surge Current Derating Curves

TVM4C450K601R

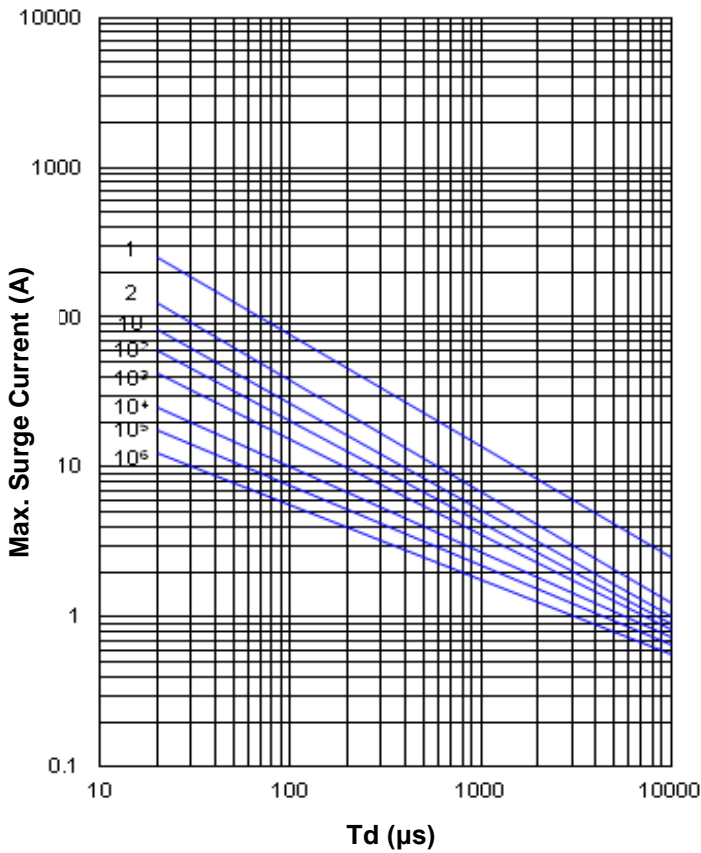

TVM4C310K122R/TVM4C340K112R

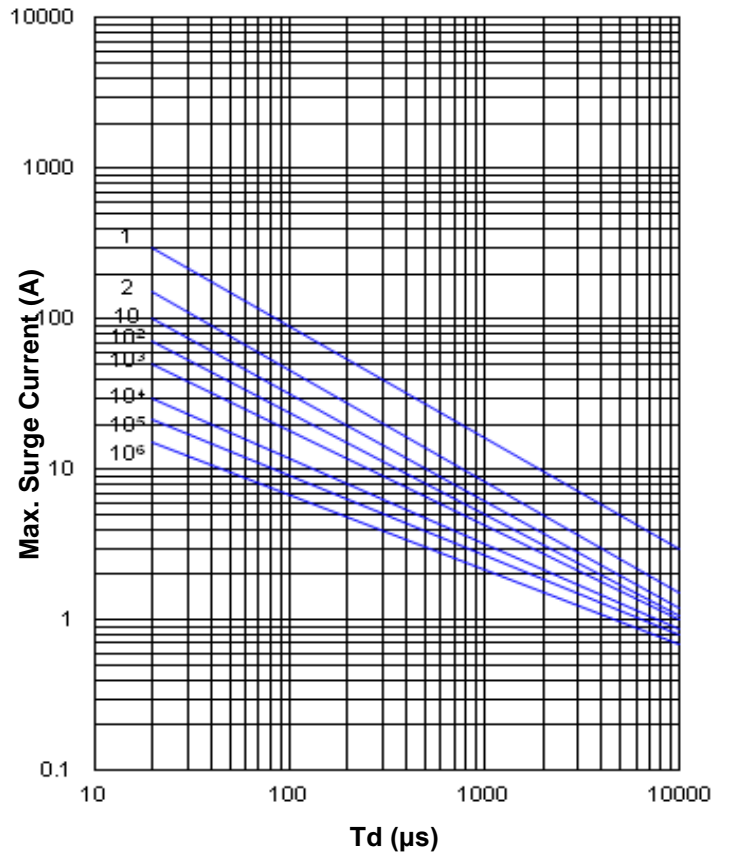

TVM4C160K242R/TVM4C260K152R

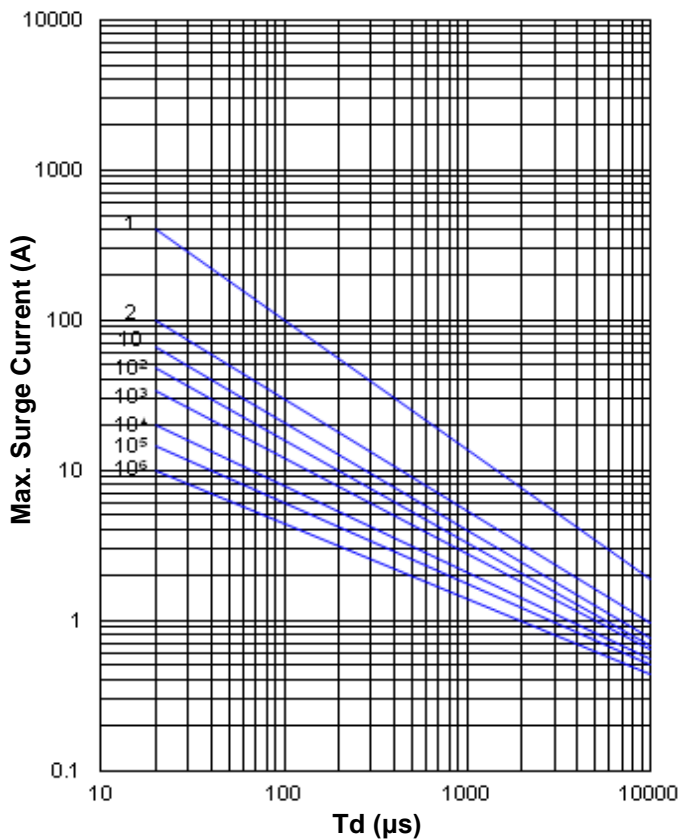

TVM4C180K312R

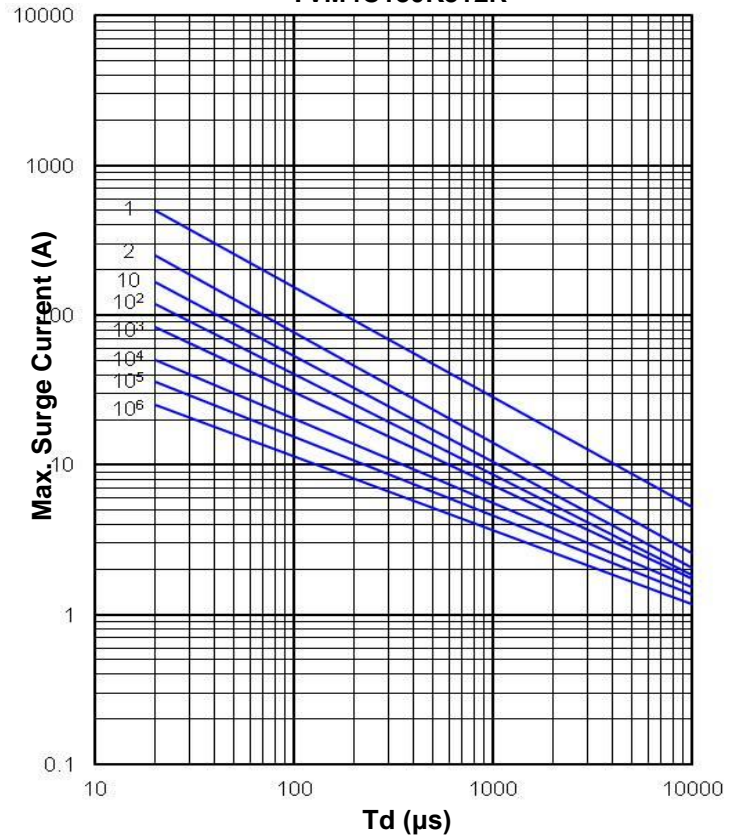

# Metal Oxide Varistor for Automotive: TVM-C Series

## SMD Type for Transient Overvoltage Protection



### Max. Surge Current Derating Curves

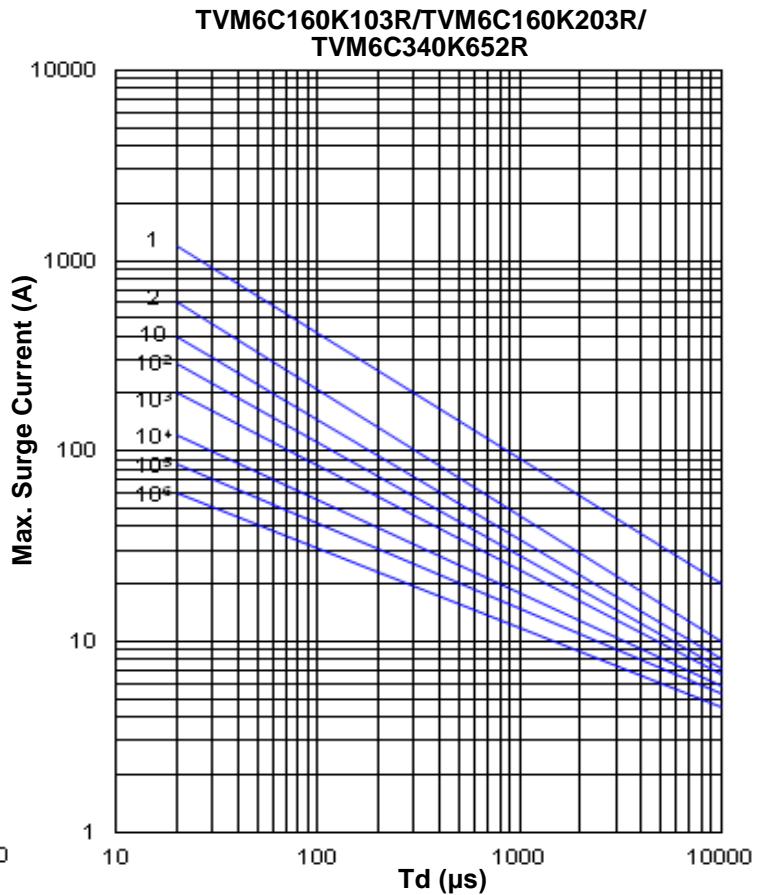
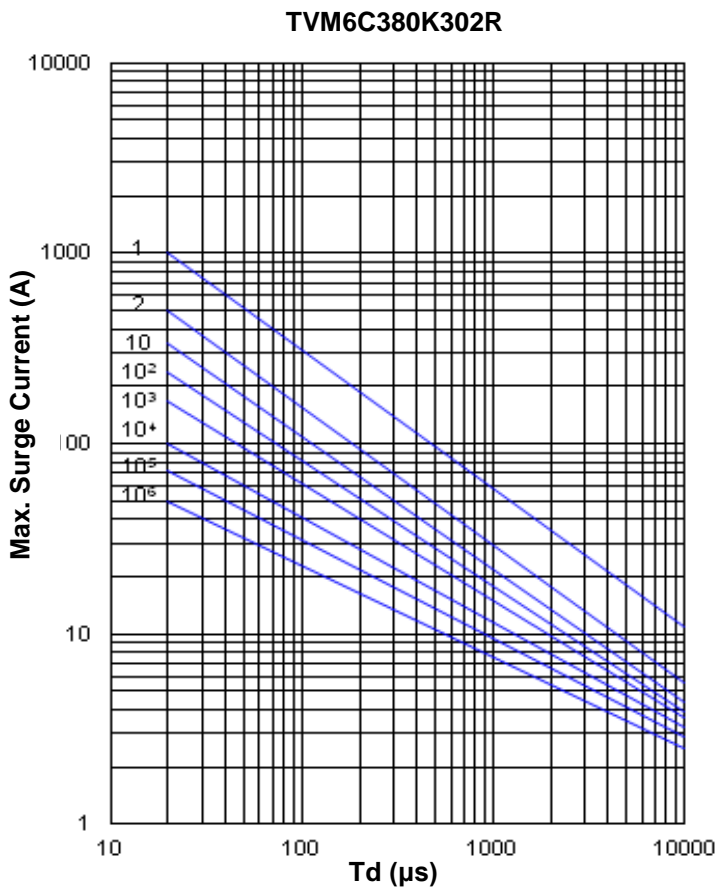
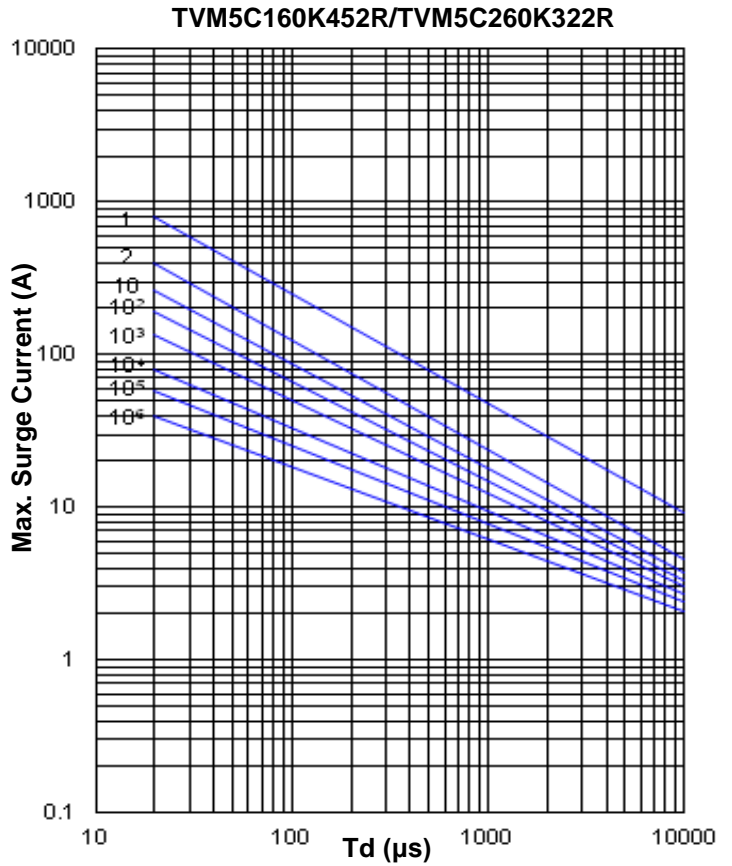
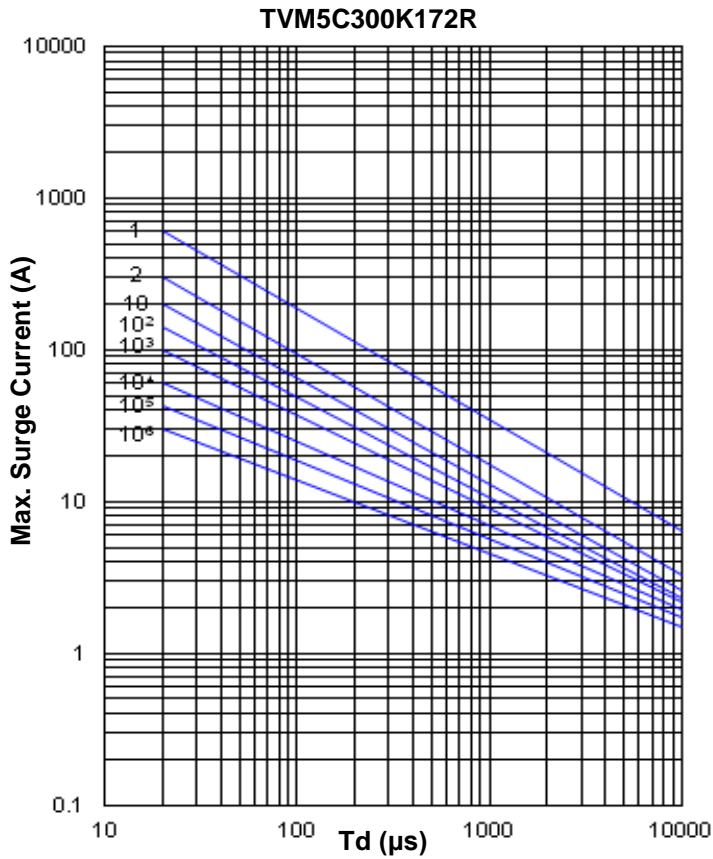

# Metal Oxide Varistor for Automotive: TVM-C Series

## SMD Type for Transient Overvoltage Protection



### Max. Leakage Current and Max. Clamping Voltage Curves

Max. Leakage Current and Max. Clamping Voltage Curves (TVM0C140K800R~TVM0C180M120R)

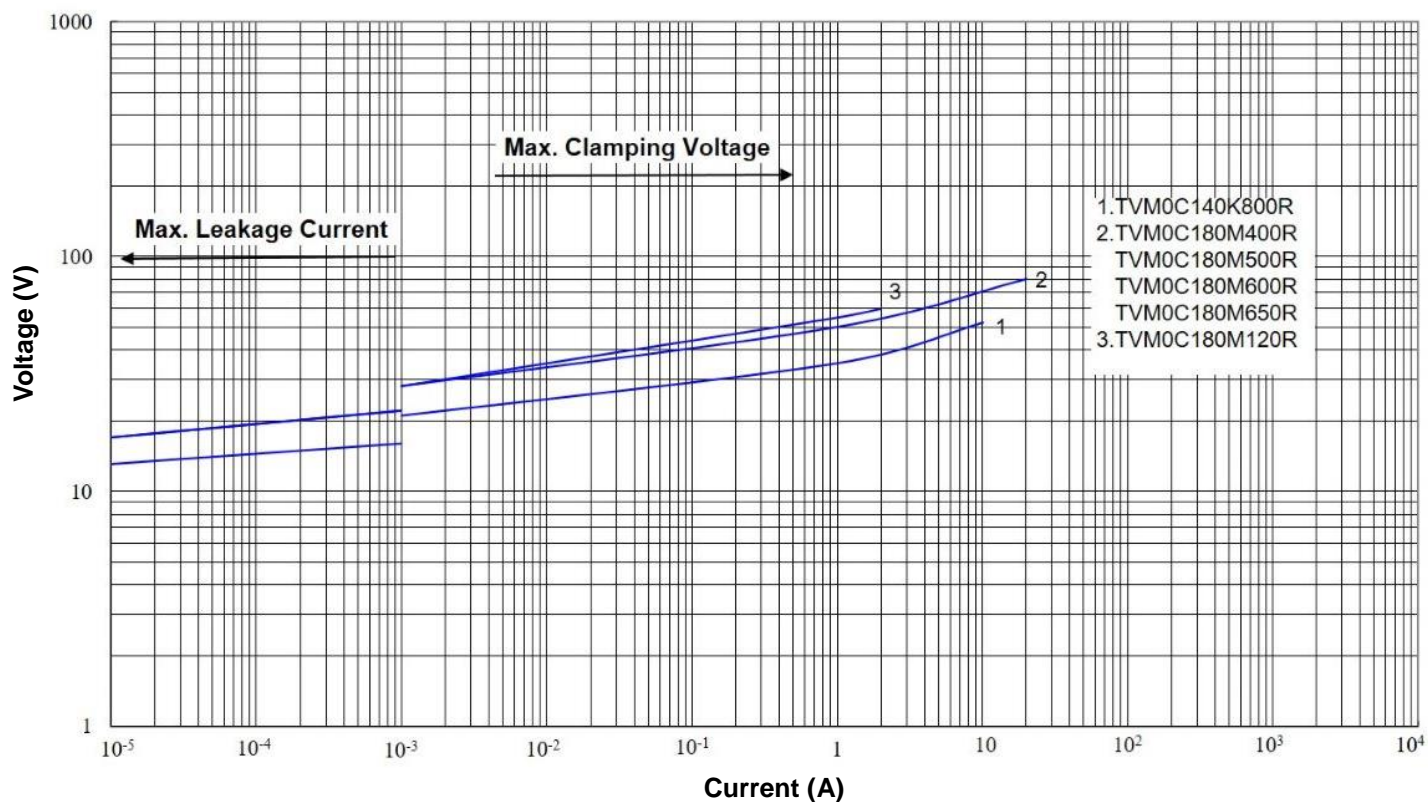

Max. Leakage Current and Max. Clamping Voltage Curves (TVM1C5R5M271R~TVM1C310K900R)

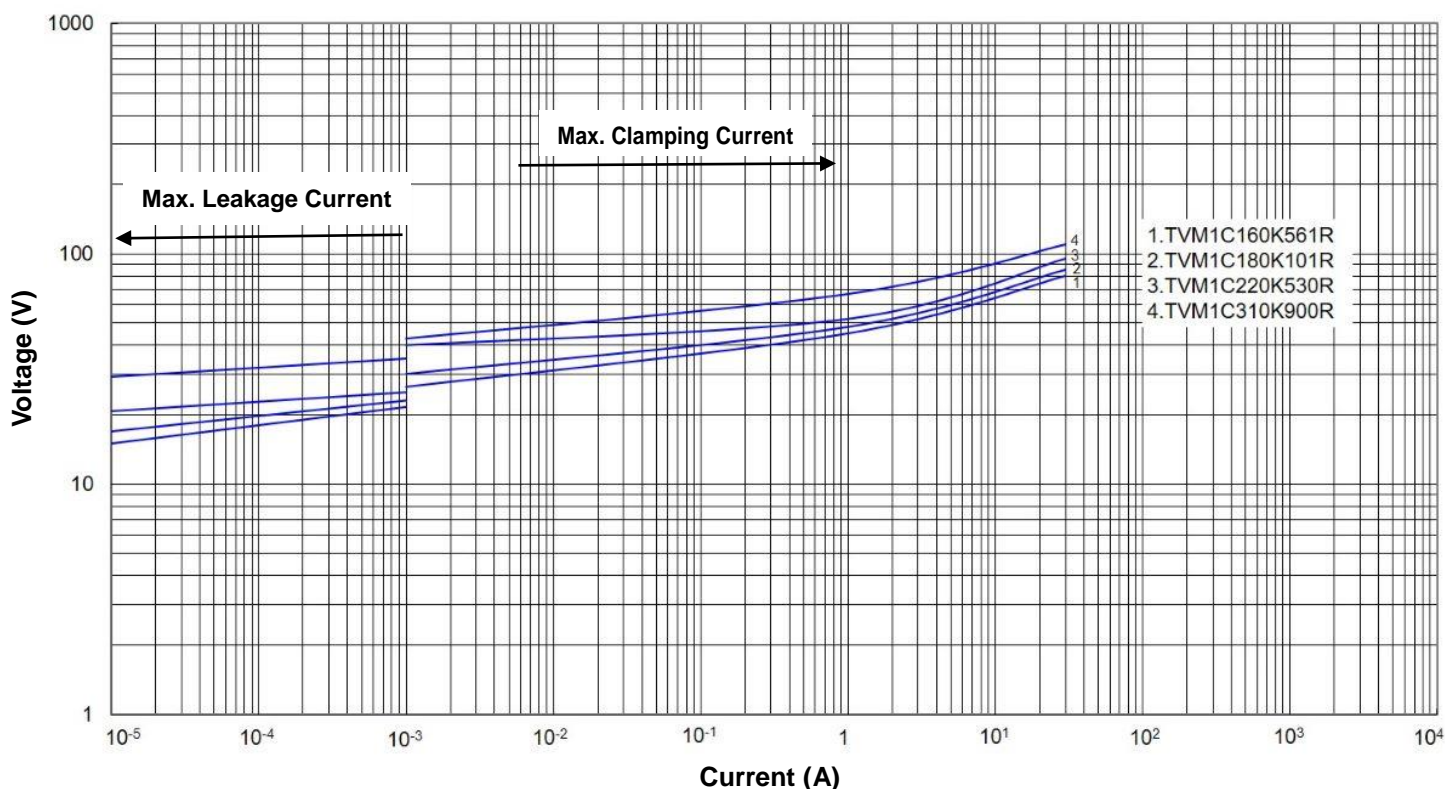

# Metal Oxide Varistor for Automotive: TVM-C Series

## SMD Type for Transient Overvoltage Protection



### Max. Leakage Current and Max. Clamping Voltage Curves

Max. Leakage Current and Max. Clamping Voltage Curves (TVM1C090M491R~TVM1C320M100R)

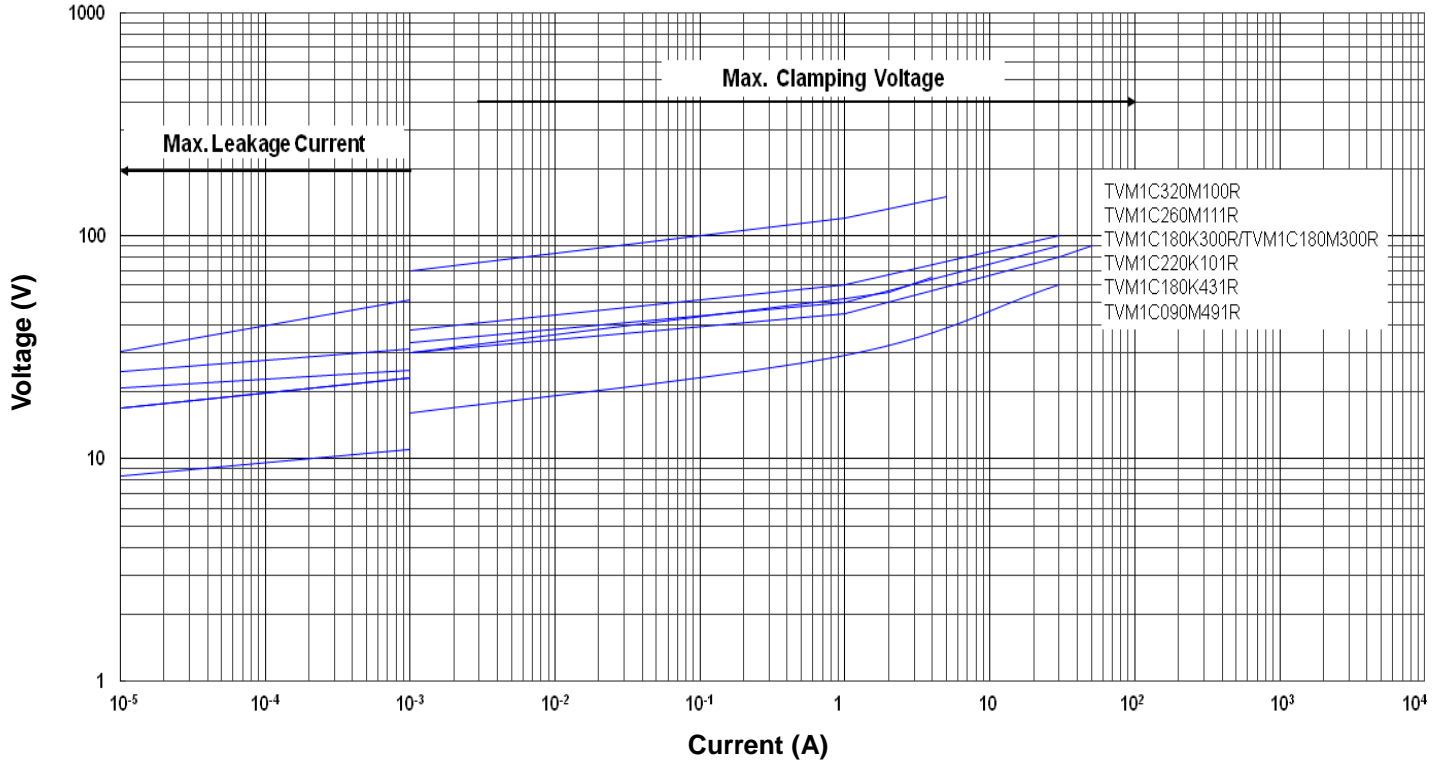

Max. Leakage Current and Max. Clamping Voltage Curves (TVM2C160K651R~TVM2C310K251R)

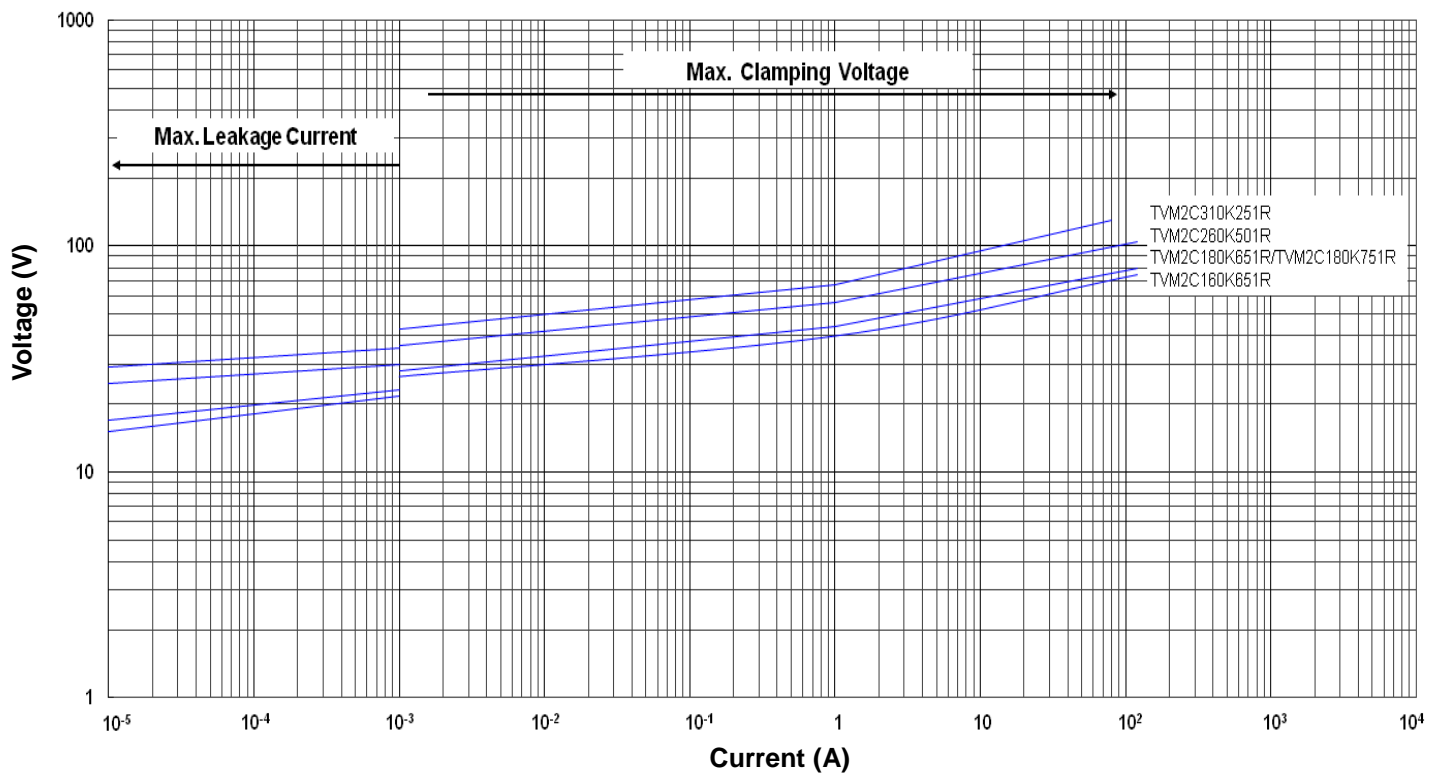

# Metal Oxide Varistor for Automotive: TVM-C Series

## SMD Type for Transient Overvoltage Protection



### Max. Leakage Current and Max. Clamping Voltage Curves

Max. Leakage Current and Max. Clamping Voltage Curves (TVM3C160K242R~TVM3C480K271R)

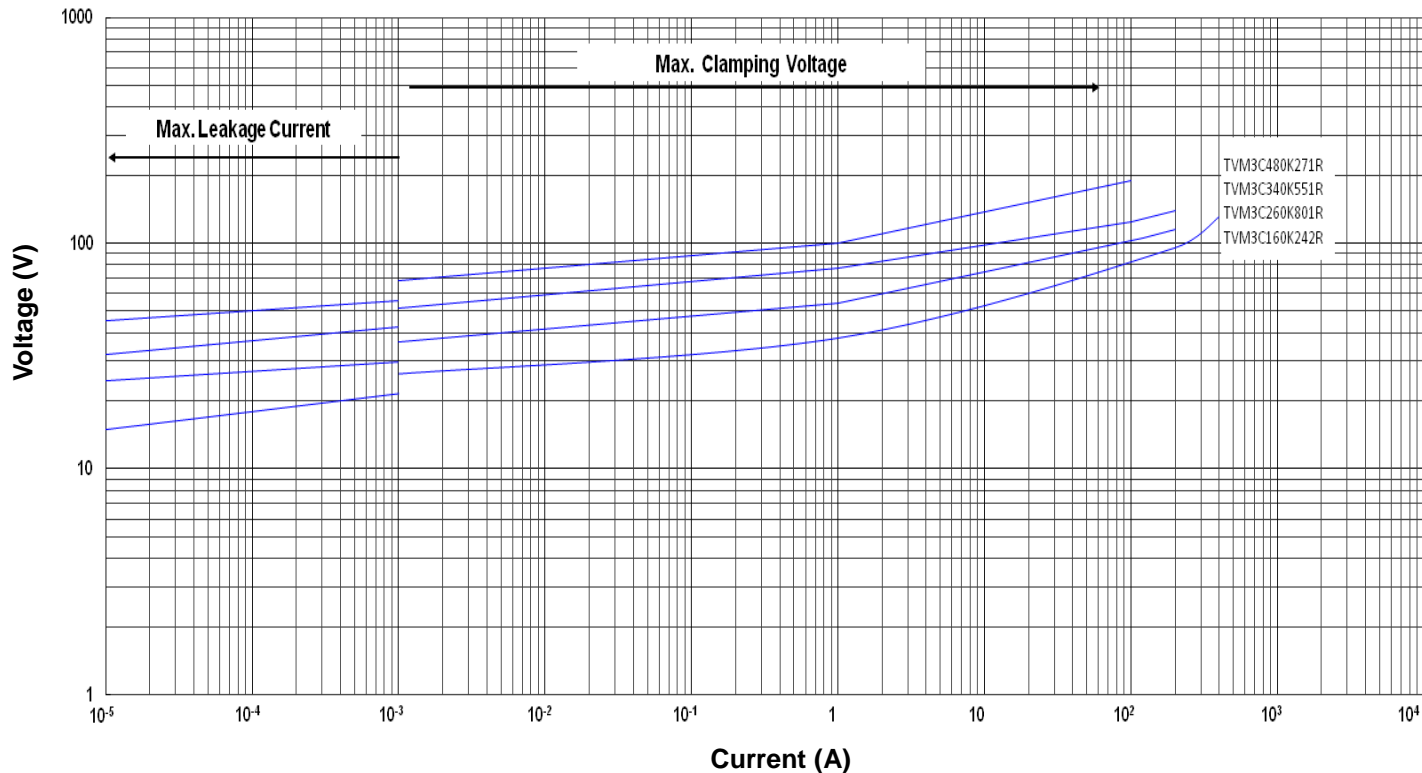

Max. Leakage Current and Max. Clamping Voltage Curves (TVM3C160K102R~TVM3C560K251R)

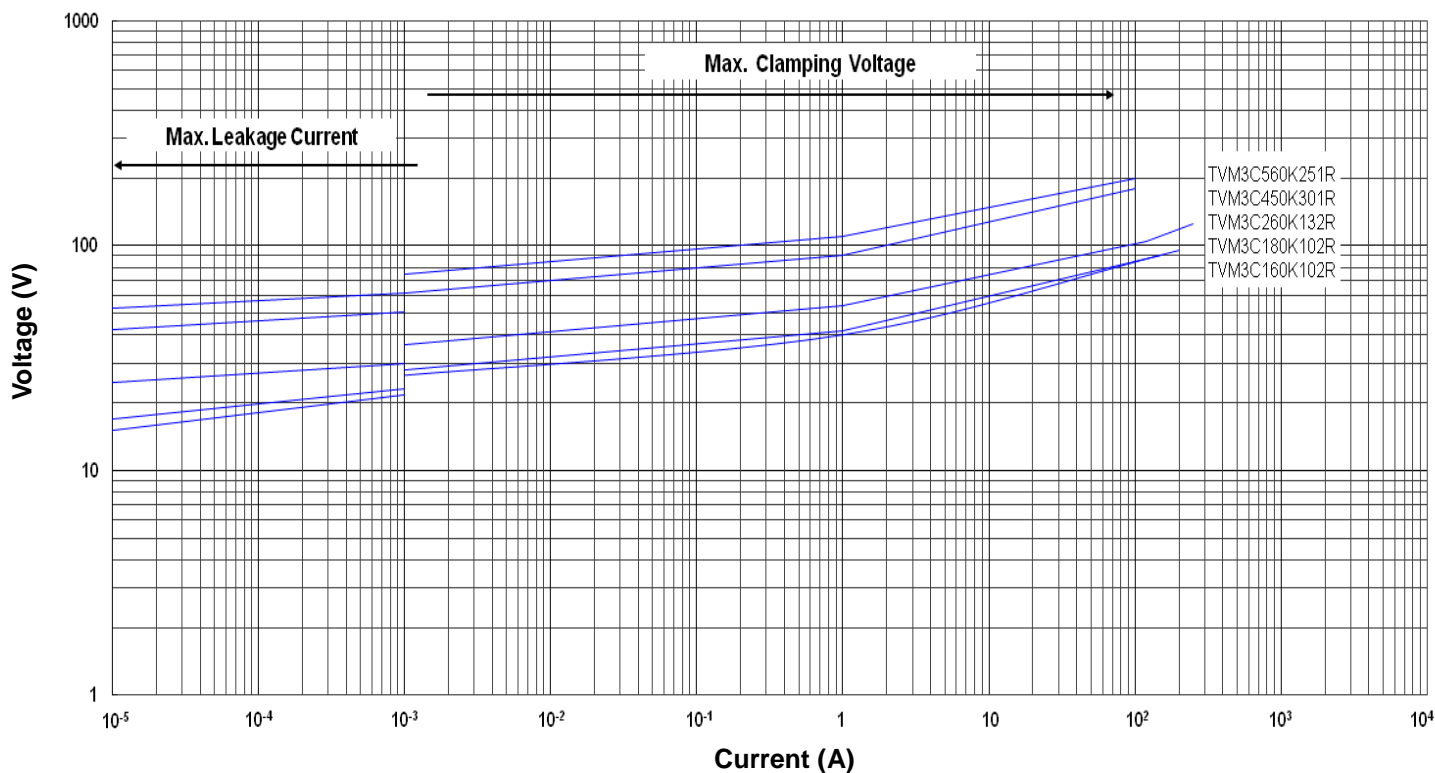

# Metal Oxide Varistor for Automotive: TVM-C Series

## SMD Type for Transient Overvoltage Protection



### ■ Max. Leakage Current and Max. Clamping Voltage Curves

Max. Leakage Current and Max. Clamping Voltage Curves (TVM4C160K242R~TVM4C560K601R)

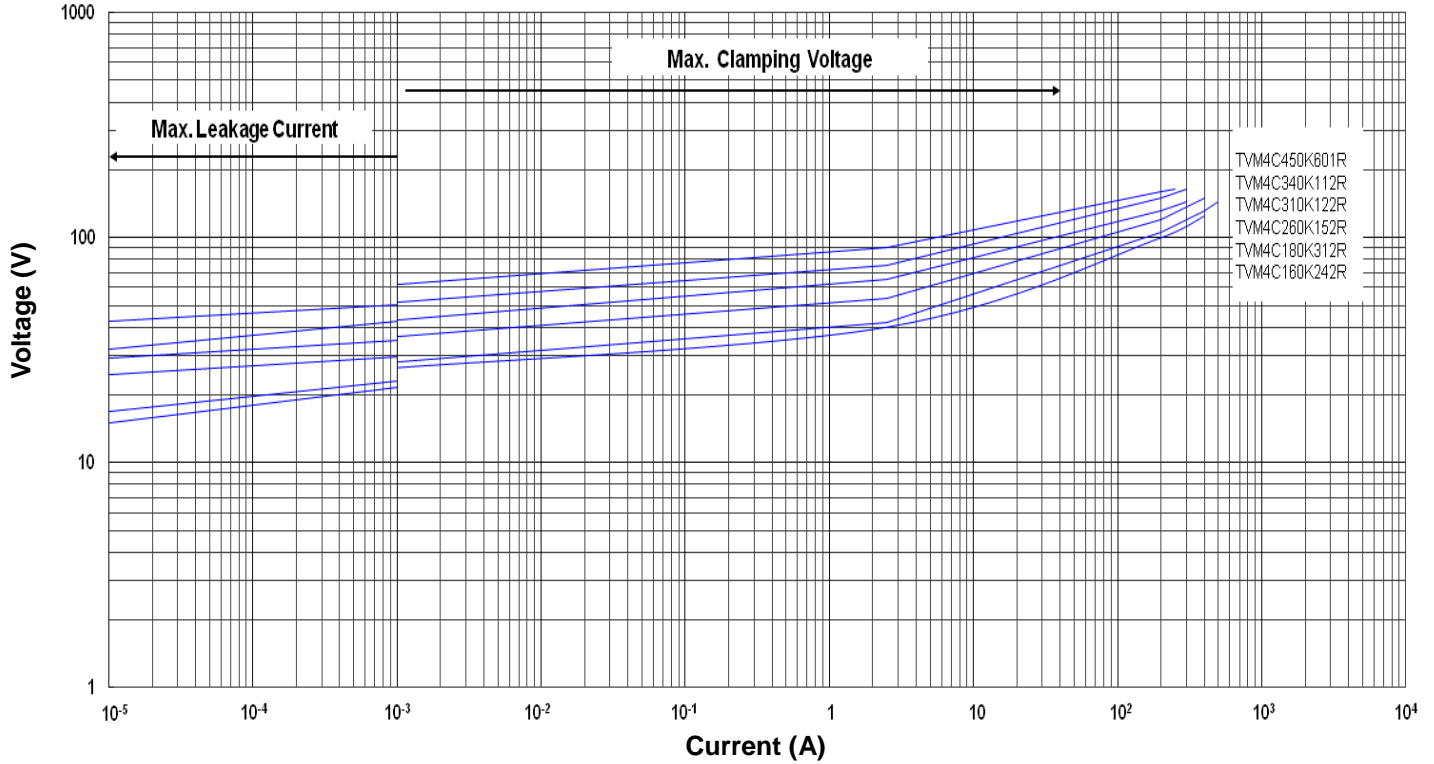

Max. Leakage Current and Max. Clamping Voltage Curves (TVM5C160K452R~TVM5C300K172R)

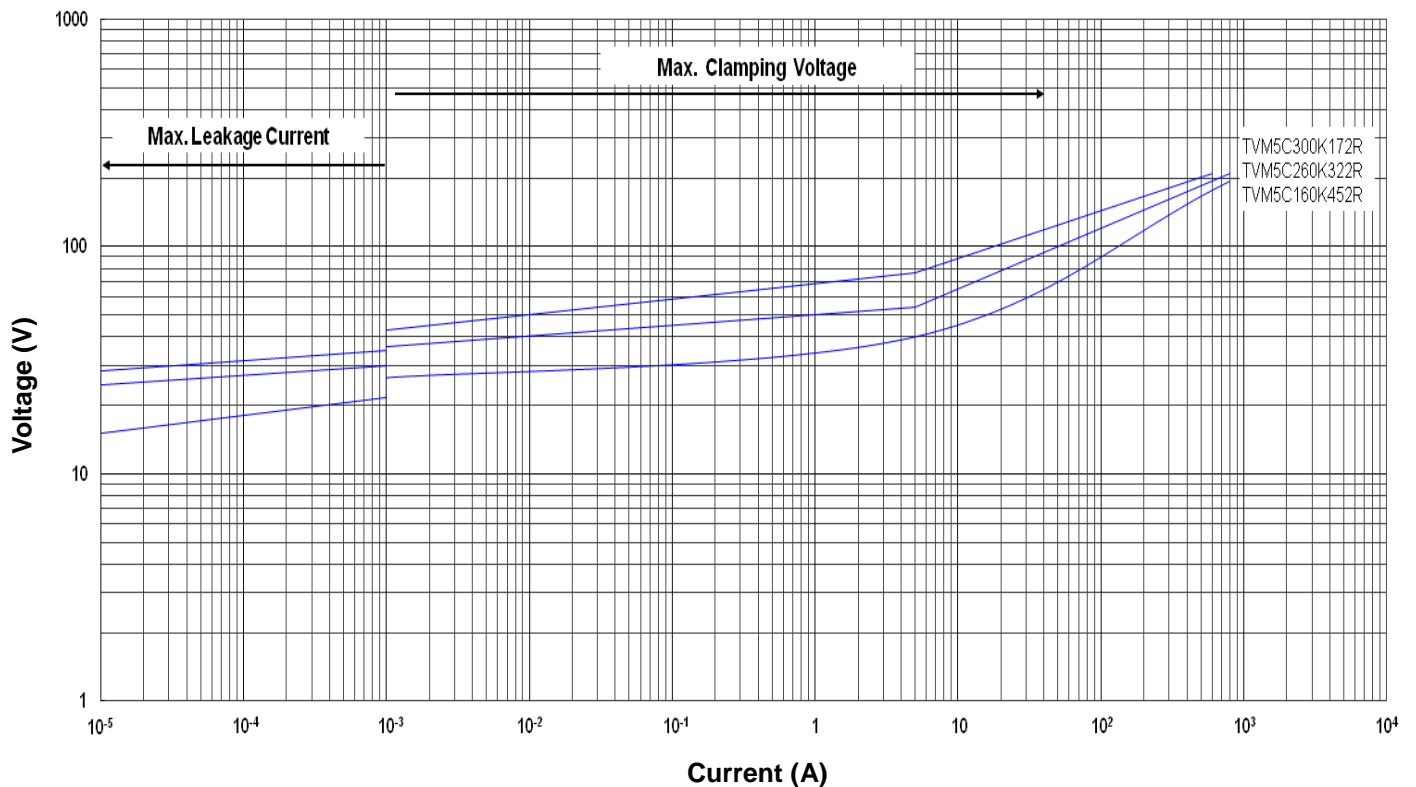

# Metal Oxide Varistor for Automotive: TVM-C Series

## SMD Type for Transient Overvoltage Protection



### Max. Leakage Current and Max. Clamping Voltage Curves

Max. Leakage Current and Max. Clamping Voltage Curves (TVM6C160K203R~TVM6C380K302R)

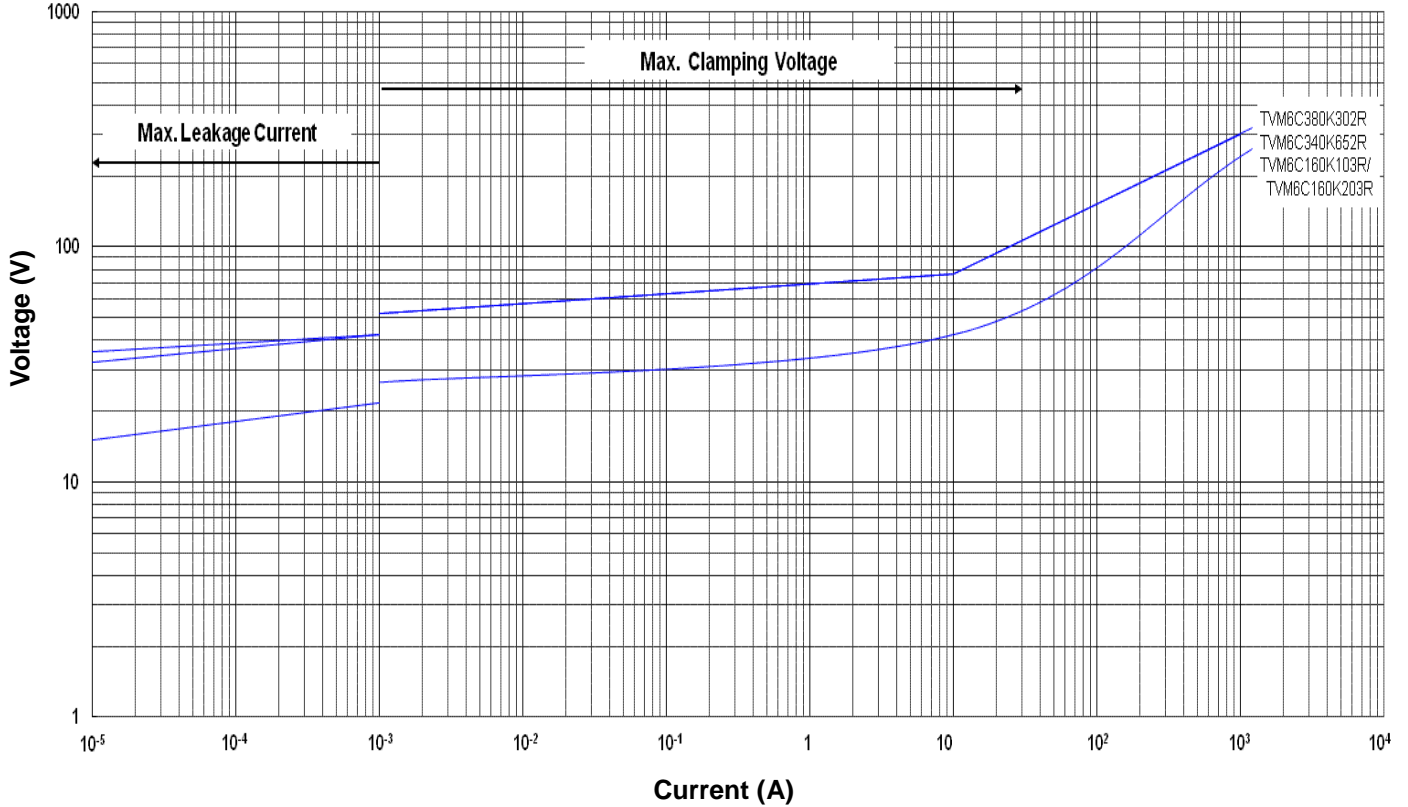

### Soldering Recommendation

#### IR-Reflow Soldering Profile

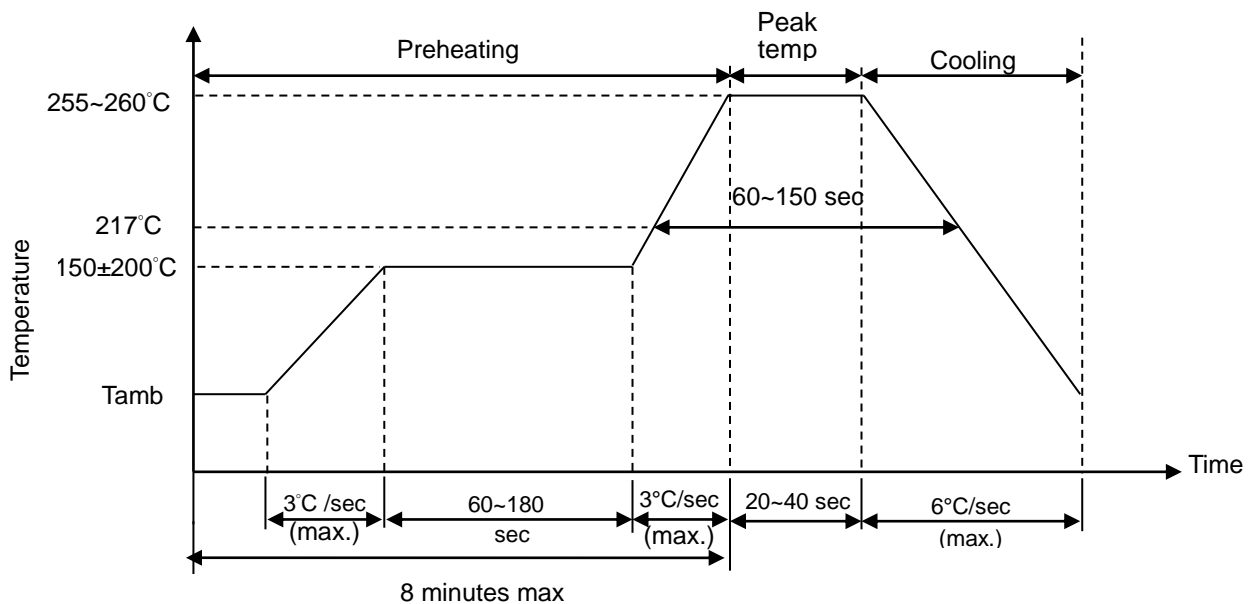

# Metal Oxide Varistor for Automotive: TVM-C Series

## SMD Type for Transient Overvoltage Protection



### ● Reworking Conditions with Soldering Iron

Item	Conditions
Temperature of Soldering Iron-tip	360°C (max.)
Soldering Time	3 sec (max.)
Diameter of Soldering Iron-tip	Φ3mm (max.)

Caution: Do not touch the component surface with soldering iron directly to prevent it from damage.

### ■ Recommended Soldering Pad Dimensions

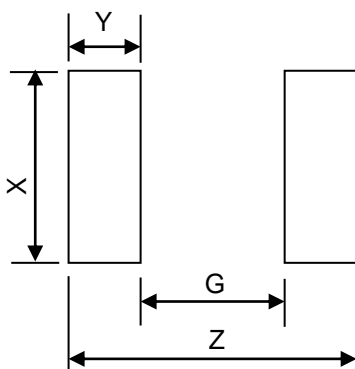

Size	Z (mm)	G (mm)	X (mm)	Y (mm)
0402	1.7	0.5	0.6	0.6
0603	2.8	0.8	1.0	1.0
0805	3.4	1.0	1.4	1.2
1206	4.5	2.1	1.8	1.2
1210	4.5	2.1	2.8	1.2
1812	6.0	3.0	3.6	1.5
2220	7.2	4.2	5.5	1.5



# Metal Oxide Varistor for Automotive: TVM-C Series

## SMD Type for Transient Overvoltage Protection



### ■ Reliability (based on AEC-Q200 Rev-C)

Item	Standard	Test conditions / Methods	Specifications																																										
High Temperature Exposure (Storage)	MIL-STD-202 Method 108	Test temp. : 150 +3/-0°C Duration: 1000 h Unpowered Measurement at 24±2 hours after test conclusion.	No visible damage   $\Delta V_{1mA}/V_{1mA}$   ≤ 10%																																										
Temperature Cycling	JESD22 Method JA-104	Lower test temp. : -40 +0/-3°C Upper test temp. : 125 +3/-0°C Soak time at lower or upper temp. : 1 min Cycle time: 2 Cycles/hr Number of cycles: 1000 Measurement at 24±2 hours after test conclusion.	No visible damage   $\Delta V_{1mA}/V_{1mA}$   ≤ 10%																																										
Moisture Resistance	MIL-STD-202 Method 106	Duration of 1 cycle: 24 h Number of cycles: 10, Unpowered Measurement at 24±2 hours after test conclusion.  <table border="1" style="margin-left: auto; margin-right: auto;"> <thead> <tr> <th rowspan="2">Step</th> <th colspan="2">Temp. (°C)</th> <th rowspan="2">Humidity (%)</th> <th rowspan="2">Period (hr)</th> </tr> <tr> <th>Start</th> <th>Finish</th> </tr> </thead> <tbody> <tr> <td>1</td> <td>25</td> <td>65</td> <td>90~100</td> <td>2.5</td> </tr> <tr> <td>2</td> <td>65</td> <td>65</td> <td>90~100</td> <td>3</td> </tr> <tr> <td>3</td> <td>65</td> <td>25</td> <td>80~100</td> <td>2.5</td> </tr> <tr> <td>4</td> <td>25</td> <td>65</td> <td>90~100</td> <td>2.5</td> </tr> <tr> <td>5</td> <td>65</td> <td>65</td> <td>90~100</td> <td>3</td> </tr> <tr> <td>6</td> <td>65</td> <td>25</td> <td>80~100</td> <td>2.5</td> </tr> <tr> <td>7</td> <td>25</td> <td>25</td> <td>80~100</td> <td>8</td> </tr> </tbody> </table>	Step	Temp. (°C)		Humidity (%)	Period (hr)	Start	Finish	1	25	65	90~100	2.5	2	65	65	90~100	3	3	65	25	80~100	2.5	4	25	65	90~100	2.5	5	65	65	90~100	3	6	65	25	80~100	2.5	7	25	25	80~100	8	No visible damage   $\Delta V_{1mA}/V_{1mA}$   ≤ 10%
Step	Temp. (°C)			Humidity (%)	Period (hr)																																								
	Start	Finish																																											
1	25	65	90~100	2.5																																									
2	65	65	90~100	3																																									
3	65	25	80~100	2.5																																									
4	25	65	90~100	2.5																																									
5	65	65	90~100	3																																									
6	65	25	80~100	2.5																																									
7	25	25	80~100	8																																									
Biased Humidity	MIL-STD-202 Method 103	Test temp. : 85°C Rel. humidity of air: 85% Duration: 1000 h Bias at Working Voltage Vdc. Measurement at 24±2 hours after test conclusion.	No visible damage   $\Delta V_{1mA}/V_{1mA}$   ≤ 10%																																										

# Metal Oxide Varistor for Automotive: TVM-C Series

## SMD Type for Transient Overvoltage Protection



Item	Standard	Test conditions / Methods	Specifications
Operational Life	MIL-STD-202 Method 108	Test temp.: 125 +3/-0°C Duration: 1000 h Bias at Working Voltage Vdc. Measurement at 24±2 hours after test conclusion.	No visible damage $ \Delta V_{1mA}/V_{1mA}  \leq 10\%$
External Visual	MIL-STD-883 Method 2009	Inspect device construction, marking and workmanship.	No visible damage
Physical Dimension	JESD22 Method JB-100	Verify physical dimensions to the applicable device specification.	Within the specified values
Resistance to Solvents	MIL-STD-202 Method 215	Per MIL-STD-202 Method 215 Solvent 1: 1 part (by volume) of isopropyl alcohol 3 part (by volume) of mineral spirits.	No visible damage
Mechanical Shock	MIL-STD -202-213	Test Condition F Peak value: 1500g's Half sine waveform Normal duration (D) : 0.5ms In 3 directions perpendicularly intersecting each other (total 18 times).	No visible damage $ \Delta V_{1mA}/V_{1mA}  \leq 10\%$
Vibration	MIL-STD-202 Method 204	Acceleration: 5 g's Sweep time: 20 min Frequency range: 10 to 2000 Hz 3×12 cycles	No visible damage $ \Delta V_{1mA}/V_{1mA}  \leq 10\%$
Resistance to Soldering Heat	MIL-STD-202 Method 210	Condition B No pre-heat of samples. Temperature: 260±5°C, Time : 10±1s Immersion and emersion rate : 25mm/s ±6 mm/s Number of heat cycles: 1	No visible damage $ \Delta V_{1mA}/V_{1mA}  \leq 5\%$
Thermal Shock	MIL-STD-202 Method 107	Lower test temp. : -55 +0/-3°C Upper test temp. : 125 +3/-0°C Maximum transfer time: 20 seconds. Dwell time: 15 minutes. Air-Air. Number of cycles: 300	No visible damage $ \Delta V_{1mA}/V_{1mA}  \leq 10\%$

# Metal Oxide Varistor for Automotive: TVM-C Series

## SMD Type for Transient Overvoltage Protection



Item	Standard	Test conditions / Methods	Specifications
ESD	AEC-Q200 -002	Discharge capacitance: 150 pF Charging voltage: 6 KV Contact discharge 1 pulse in each polarity	No visible damage   $\Delta V_{1mA}/V_{1mA}$   $\leq 10\%$
Solderability	IEC 60068-2- 58 J-STD-002	a) 4 h @ 155°C dry heat Dip @245±5°C 3±0.3sec b) Steam aging 8h±15min @93±3°C Dip @260±5°C 7±0.5sec	95% of termination wetted
Electrical Characterization	Specifications	V1mA(-55°C), V1mA(25°C), V1mA(125°C)	Within the specified values
Board Flex	AEC-Q200 -005 (JIS-C-6429)	Bend the board: 2mm (Min.) Duration: 60 (+5) Sec	No visible damage   $\Delta V_{1mA}/V_{1mA}$   $\leq 10\%$
Terminal Strength	AEC-Q200 -006 (JIS-C-6429)	Apply force: 0402=0.5kg (5 N) 0603=1.0kg (10 N) Chip size>0805=1.8kg (17.7 N) Duration of the applied forces: 60 (+1) Sec	No visible damage   $\Delta V_{1mA}/V_{1mA}$   $\leq 10\%$
Electrical Transient Conduction	ISO-7637-2	Test pulses 5a Number of pulses: 10 Test Energy: W <sub>LD</sub> (Load dump )	No visible damage   $\Delta V_{1mA}/V_{1mA}$   $\leq 15\%$

# Metal Oxide Varistor for Automotive: TVM-C Series

## SMD Type for Transient Overvoltage Protection



### ■ Packaging

#### ● Taping Specification (SMD 0402)

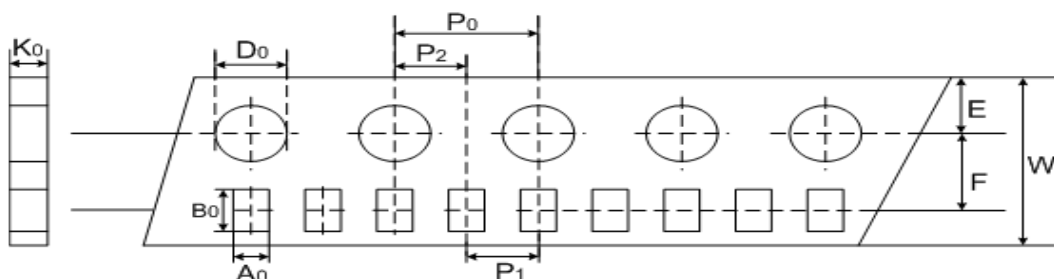

(Unit: mm)

Index	$A_0$	$B_0$	$W$	$E$	$F$	$P_1$	$P_2$	$P_0$	$D_0$	$K_0$
Size	$\pm 0.05$	$\pm 0.12$	$\pm 0.2$	$\pm 0.1$	$\pm 0.05$	$\pm 0.1$	$\pm 0.05$	$\pm 0.1$	$\pm 0.1$	$\pm 0.1$
0402	0.62	1.12	8	1.75	3.5	2	2	4	1.55	0.60

#### ● Taping Specification (SMD 0603 & 0805)

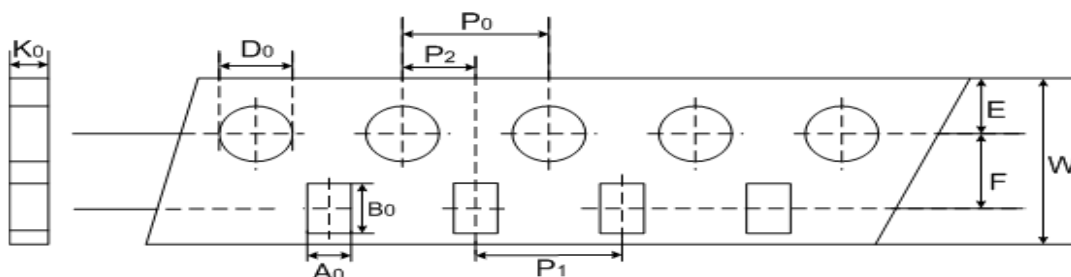

(Unit: mm)

Index	$A_0$	$B_0$	$W$	$E$	$F$	$P_1$	$P_2$	$P_0$	$D_0$	$K_0$
Size	$\pm 0.2$	$\pm 0.2$	$\pm 0.2$	$\pm 0.1$	$\pm 0.05$	$\pm 0.1$	$\pm 0.05$	$\pm 0.1$	$\pm 0.1$	$\pm 0.1$
0603	1.1	1.9	8	1.75	3.5	4	2	4	1.55	0.95
0805	1.5	2.3	8	1.75	3.5	4	2	4	1.55	1.0

# Metal Oxide Varistor for Automotive: TVM-C Series

## SMD Type for Transient Overvoltage Protection



### ● Taping Specification(SMD 1206 & 1210)

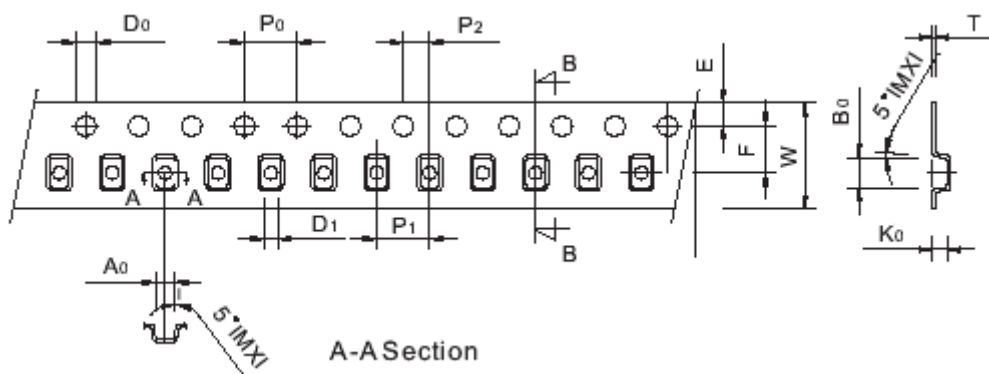

(Unit: mm)

Index Size	A <sub>0</sub>	B <sub>0</sub>	W	E	F	P <sub>1</sub>	P <sub>2</sub>	P <sub>0</sub>	D <sub>0</sub>	D <sub>1</sub>	T
1206	±0.2	±0.2	±0.2	±0.1	±0.05	±0.1	±0.05	±0.1	±0.1	±0.1	±0.1
1210	2.75	3.55	8	1.75	3.5	4	2	4	1.55	1	0.25

### ● Taping Specification(SMD 1812 ~ 2220)

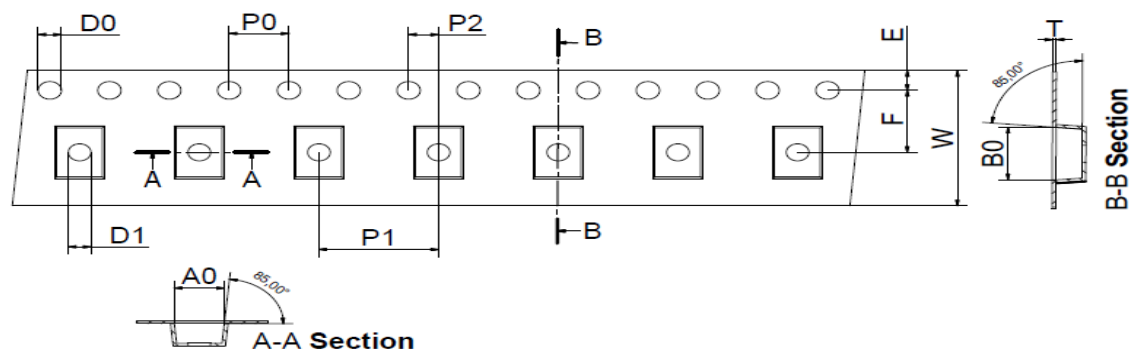

(Unit: mm)

Index Size	A <sub>0</sub>	B <sub>0</sub>	W	E	F	P <sub>1</sub>	P <sub>2</sub>	P <sub>0</sub>	D <sub>0</sub>	D <sub>1</sub>	T
1812	±0.2	±0.2	±0.3	±0.1	±0.05	±0.1	±0.05	±0.1	±0.1	±0.1	±0.1
2220	5.50	6.25	12	1.75	5.5	8	2	4	1.55	1.5	0.25

# Metal Oxide Varistor for Automotive: TVM-C Series

## SMD Type for Transient Overvoltage Protection



- Quantity

- ◆ 0402 ~ 1210

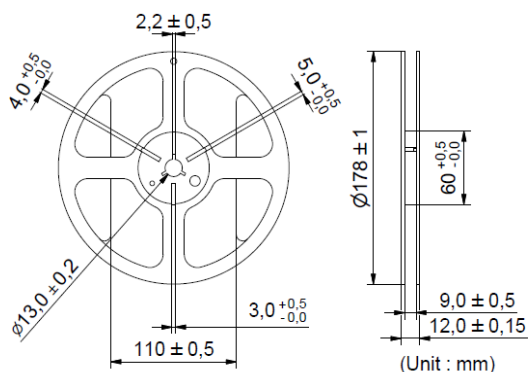

Type	Quantity (pcs/reel)
0402	10,000
0603	4,000
0805	3,000
1206	2,000
1210	2,000

- ◆ 1812~2220

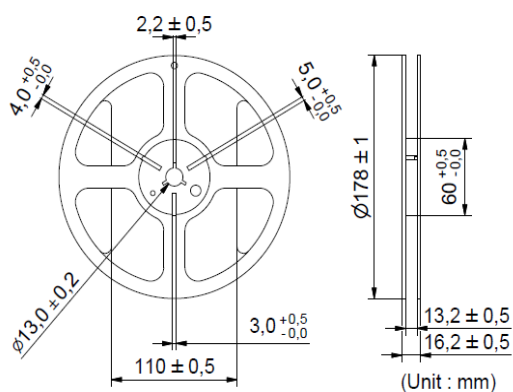

Type	Quantity (pcs/reel)
1812	1,000
2220	800

### ■ Warehouse Storage Conditions of Products

- Storage Conditions :

1. Storage Temperature: -10°C ~ +40°C
2. Relative Humidity: ≤ 75%RH
3. Keep away from corrosive atmosphere and sunlight.

- Period of Storage : 1 year