

# Transient Voltage Suppression Diodes: P4SMA Series

## SMD Type 400 W



### ■ Features

1. Glass passivated chip
2. 400W peak pulse power capability at 10/1000µs waveform, repetition rate (duty cycle): 0.01%
3. Excellent clamping capability
4. Very fast response time
5. Low clamping voltage
6. Low leakage current
7. Meets MSL level 1, per J-STD-020, LF maximum peak of 260°C
8. JESD22-A114-B ESD Voltage: HBM 15KV
9. JEDEC EIA/JESD22-C101F ESD Voltage: CDM 500V
10. JEDEC EIA/JESD22-A115 ESD Voltage: MM 400V
11. ESD-immunity acc. IEC 61000-4-2 ±30kV(contact), ±30kV(air)
12. Halogen free and RoHS compliant

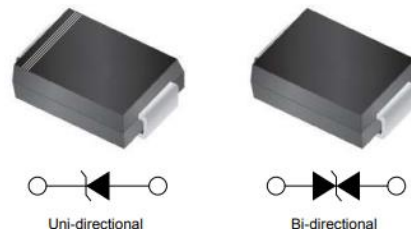

### ■ Recommended Applications

1. Computers
2. Telecom system
3. Industrial equipment
4. Consumer electronic applications
5. Other VCC bus and I/O interfaces

### ■ Mechanical Data

1. Case: Molded plastic, SMA / DO-214AC
2. Epoxy: UL 94V-0 rate flame retardant
3. Terminals: Solderable per MIL-STD-750, method 2026
4. Polarity: Color band denotes cathode end
5. Mounting Position: Any

### ■ Part Number Code

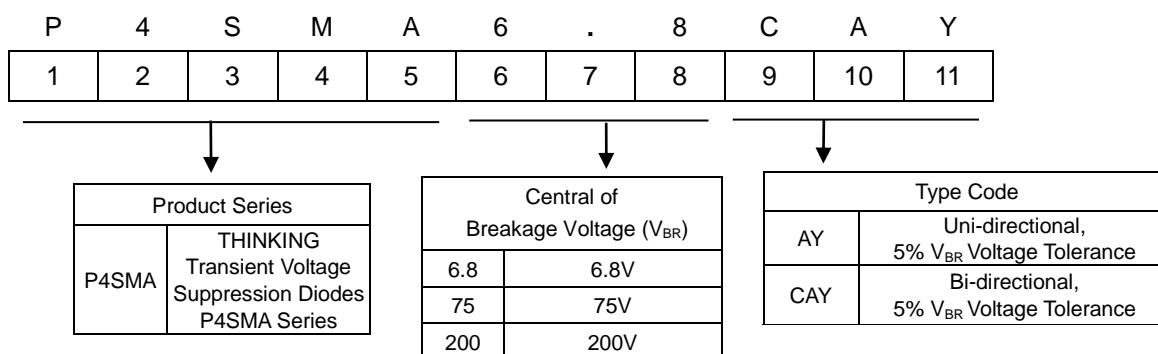

# Transient Voltage Suppression Diodes: P4SMA Series

## SMD Type 400 W



### Structures and Dimensions

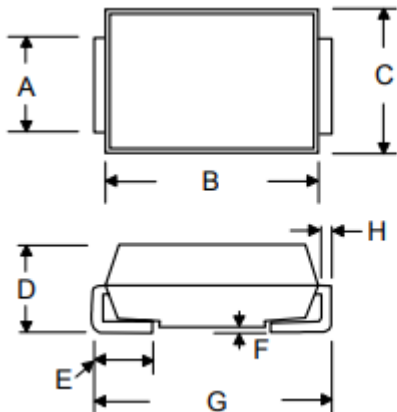

Symbol	Dimensions in millimeters	
	Min	Max
A	1.30	1.70
B	3.90	4.50
C	2.40	2.80
D	2.00	2.50
E	0.76	1.52
F	0.10	0.20
G	4.80	5.30
H	0.15	0.31

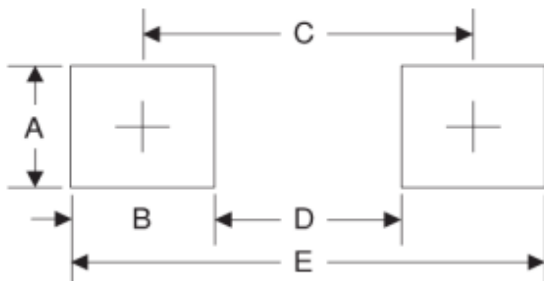

Symbol	Unit (mm)	Unit (inch)
A	1.68	0.066
B	1.52	0.060
C	3.90	0.154
D	2.41	0.095
E	5.45	0.215

### Maximum Rating ( $T_A=25^\circ\text{C}$ unless otherwise noted)

Parameter	Symbol	Value	Unit
Peak power dissipation with a 10/1000 $\mu\text{s}$ waveform (Note 1,2)	$P_{PPM}$	400	W
Peak pulse current with 10/1000 $\mu\text{s}$ waveform (Note 1)	$I_{PPM}$	See next table	A
Peak forward surge current, 8.3 ms single half sine-wave (Note 3)	$I_{FSM}$	40	A
Power dissipation on infinite heatsink at $T_L=75^\circ\text{C}$	$P_D$	3.3	W
Typical thermal resistance junction to ambient	$R_{\theta JA}$	120	$^\circ\text{C/W}$
Typical thermal resistance junction to lead	$R_{\theta JL}$	30	$^\circ\text{C/W}$
Operating junction and storage temperature range	$T_J, T_{STG}$	-55 to +150	$^\circ\text{C}$

Note:

1. Non-repetitive current pulse, per Fig. 3 and derated above  $T_A=25^\circ\text{C}$  per Fig. 2.
2. Mounted on 5.0 x 5.0mm copper pad to each terminal.
3. Measured on 8.3ms single half sine wave or equivalent square wave for unidirectional device only, duty cycle=4 per minute maximum.

# Transient Voltage Suppression Diodes: P4SMA Series

## SMD Type 400 W



### ■ Electrical Characteristics (T<sub>A</sub>=25°C unless otherwise noted)

Part No. (Uni)	Part No. (Bi)	Reverse Stand off Voltage	Breakage Voltage V <sub>BR</sub> @ I <sub>T</sub>		Test Current	Maximum Clamping Voltage V <sub>C</sub> @ I <sub>pp</sub>	Maximum Peak Pulse Current	Maximum Reverse Leakage I <sub>R</sub> @ V <sub>RWM</sub>	Marking Code	
		V <sub>RWM</sub> (V)	Min(V)	Max(V)	I <sub>T</sub> (mA)	V <sub>C</sub> (V)	I <sub>pp</sub> (A)	I <sub>R</sub> (μA)	Uni	Bi
P4SMA6.8AY	P4SMA6.8CAY	5.8	6.45	7.14	10	10.5	39	1000	6.8A	6.8C
P4SMA7.5AY	P4SMA7.5CAY	6.4	7.13	7.88	10	11.3	36.3	500	7.5A	7.5C
P4SMA8.2AY	P4SMA8.2CAY	7.02	7.79	8.61	10	12.1	33.9	200	8.2A	8.2C
P4SMA9.1AY	P4SMA9.1CAY	7.78	8.65	9.55	1	13.4	30.6	50	9.1A	9.1C
P4SMA10AY	P4SMA10CAY	8.55	9.5	10.5	1	14.5	28.3	10	10A	10C
P4SMA11AY	P4SMA11CAY	9.4	10.5	11.6	1	15.6	26.3	5	11A	11C
P4SMA12AY	P4SMA12CAY	10.2	11.4	12.6	1	16.7	24.6	5	12A	12C
P4SMA13AY	P4SMA13CAY	11.1	12.4	13.7	1	18.2	22.5	1	13A	13C
P4SMA15AY	P4SMA15CAY	12.8	14.3	15.8	1	21.2	19.3	1	15A	15C
P4SMA16AY	P4SMA16CAY	13.6	15.2	16.8	1	22.5	18.2	1	16A	16C
P4SMA18AY	P4SMA18CAY	15.3	17.1	18.9	1	25.5	16.1	1	18A	18C
P4SMA20AY	P4SMA20CAY	17.1	19	21	1	27.7	14.8	1	20A	20C
P4SMA22AY	P4SMA22CAY	18.8	20.9	23.1	1	30.6	13.4	1	22A	22C
P4SMA24AY	P4SMA24CAY	20.5	22.8	25.2	1	33.2	12.3	1	24A	24C
P4SMA27AY	P4SMA27CAY	23.1	25.7	28.4	1	37.5	10.9	1	27A	27C
P4SMA30AY	P4SMA30CAY	25.6	28.5	31.5	1	41.4	9.9	1	30A	30C
P4SMA33AY	P4SMA33CAY	28.2	31.4	34.7	1	45.7	9	1	33A	33C
P4SMA36AY	P4SMA36CAY	30.8	34.2	37.8	1	49.9	8.2	1	36A	36C
P4SMA39AY	P4SMA39CAY	33.3	37.1	41	1	53.9	7.6	1	39A	39C
P4SMA43AY	P4SMA43CAY	36.8	40.9	45.2	1	59.3	6.9	1	43A	43C
P4SMA47AY	P4SMA47CAY	40.2	44.7	49.4	1	64.8	6.3	1	47A	47C
P4SMA51AY	P4SMA51CAY	43.6	48.5	53.6	1	70.1	5.8	1	51A	51C
P4SMA56AY	P4SMA56CAY	47.8	53.2	58.8	1	77	5.3	1	56A	56C
P4SMA62AY	P4SMA62CAY	53	58.9	65.1	1	85	4.8	1	62A	62C
P4SMA68AY	P4SMA68CAY	58.1	64.6	71.4	1	92	4.5	1	68A	68C
P4SMA75AY	P4SMA75CAY	64.1	71.3	78.8	1	103	4	1	75A	75C
P4SMA82AY	P4SMA82CAY	70.1	77.9	86.1	1	113	3.6	1	82A	82C
P4SMA91AY	P4SMA91CAY	77.8	86.5	95.5	1	125	3.3	1	91A	91C
P4SMA100AY	P4SMA100CAY	85.5	95	105	1	137	3	1	100A	100C

# Transient Voltage Suppression Diodes: P4SMA Series

## SMD Type 400 W



### ■ Electrical Characteristics (T<sub>A</sub>=25°C unless otherwise noted)

Part No. (Uni)	Part No. (Bi)	Reverse Stand off Voltage	Breakage Voltage V <sub>BR</sub> @ I <sub>T</sub>		Test Current	Maximum Clamping Voltage V <sub>C</sub> @ I <sub>pp</sub>	Maximum Peak Pulse Current	Maximum Reverse Leakage I <sub>R</sub> @ V <sub>RWM</sub>	Marking Code	
			V <sub>RWM</sub> ( V )	Min( V )					Max( V )	I <sub>T</sub> ( mA )
P4SMA110AY	P4SMA110CAY	94	105	116	1	152	2.7	1	110A	110C
P4SMA120AY	P4SMA120CAY	102	114	126	1	165	2.5	1	120A	120C
P4SMA130AY	P4SMA130CAY	111	124	137	1	179	2.3	1	130A	130C
P4SMA150AY	P4SMA150CAY	128	143	158	1	207	2	1	150A	150C
P4SMA160AY	P4SMA160CAY	136	152	168	1	219	1.9	1	160A	160C
P4SMA170AY	P4SMA170CAY	145	162	179	1	234	1.8	1	170A	170C
P4SMA180AY	P4SMA180CAY	154	171	189	1	246	1.7	1	180A	180C
P4SMA200AY	P4SMA200CAY	171	190	210	1	274	1.5	1	200A	200C
P4SMA220AY	P4SMA220CAY	185	209	231	1	328	1.3	1	220A	220C
P4SMA250AY	P4SMA250CAY	214	237	263	1	344	1.2	1	250A	250C
P4SMA300AY	P4SMA300CAY	256	285	315	1	414	1	1	300A	300C
P4SMA350AY	P4SMA350CAY	300	332	368	1	482	0.9	1	350A	350C
P4SMA400AY	P4SMA400CAY	342	380	420	1	548	0.8	1	400A	400C
P4SMA440AY	P4SMA440CAY	376	418	462	1	602	0.7	1	440A	440C
P4SMA480AY	P4SMA480CAY	408	456	504	1	658	0.6	1	480A	480C
P4SMA510AY	P4SMA510CAY	434	485	535	1	698	0.6	1	510A	510C
P4SMA530AY	P4SMA530CAY	450	503.5	556.5	1	725	0.6	1	530A	530C
P4SMA540AY	P4SMA540CAY	459	513	567	1	740	0.5	1	540A	540C
P4SMA550AY	P4SMA550CAY	467	522.5	577.5	1	760	0.5	1	550A	550C

# Transient Voltage Suppression Diodes: P4SMA Series

## SMD Type 400 W



### ■ Typical Characteristics ( $T_A=25^\circ\text{C}$ unless otherwise noted)

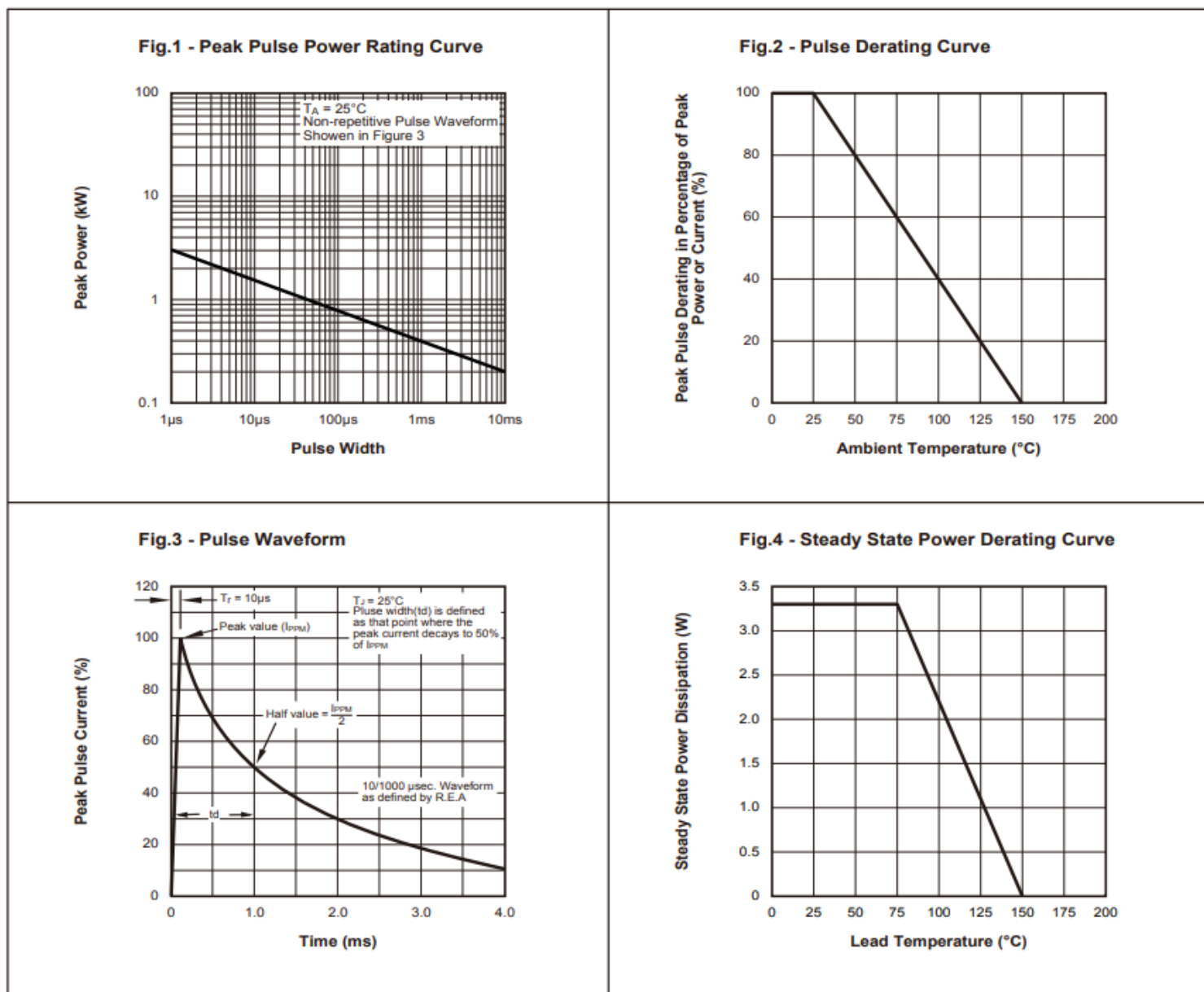

# Transient Voltage Suppression Diodes: P4SMA Series

## SMD Type 400 W



### ■ Soldering Recommendation

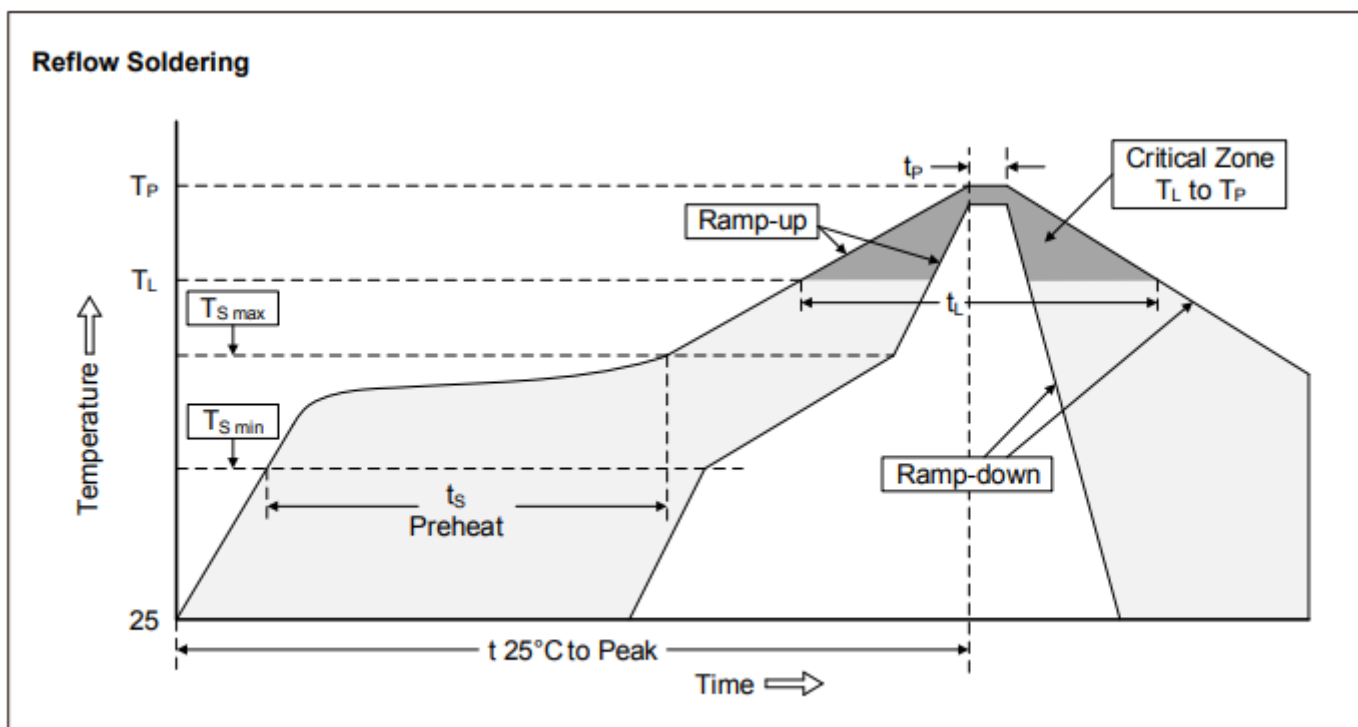

### Recommended Conditions

Profile Feature	Pb-Free Assembly
Average ramp-up rate ( $T_L$ to $T_P$ )	3°C/second max.
Preheat	
-Temperature Min ( $T_{S\ min}$ )	150°C
-Temperature Max ( $T_{S\ max}$ )	200°C
-Time (min to max) ( $t_s$ )	60-180 seconds
$T_{S\ max}$ to $T_L$	
-Ramp-up Rate	3°C/second max.
Time maintained above:	
-Temperature ( $T_L$ )	217°C
-Time ( $t_L$ )	60-150 seconds
Peak Temperature ( $T_P$ )	260°C
Time within 5°C of actual Peak Temperature ( $t_p$ )	20-40 seconds
Ramp-down Rate	6°C/second max.
Time 25°C to Peak Temperature	8 minutes max.

# Transient Voltage Suppression Diodes: P4SMA Series

## SMD Type 400 W



### ■ Packaging

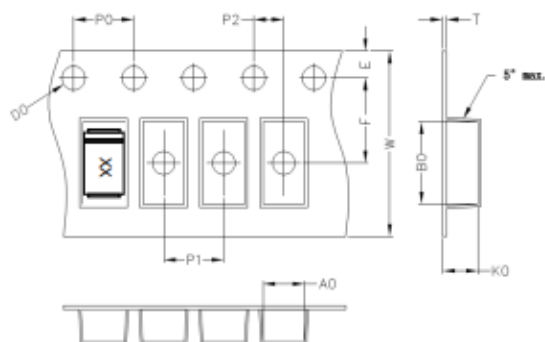

A0	B0	K0	D0	E	F
2.80	5.30	2.36	1.55	1.75	5.50
P0	P1	P2	T	W	Tolerance
4.0	4.0	2.0	0.25	12	0.1

### ■ Quantity

Series Type	Packaging option	Base quantity	Packaging specification
P4SMA	Tape and reel	7500pcs / reel	EIA STD RS-481

### ■ Warehouse Storage Conditions of product

- Storage Condition:
  - Storage Temperature:  $-10^{\circ}\text{C} \sim +40^{\circ}\text{C}$
  - Relative Humidity:  $\leq 75\% \text{RH}$
  - Keep away from corrosive atmosphere and sunlight.
- Period of Storage: 1 year.