

## SMD Type 400 W

### ■ Features

1. Glass passivated chip
2. 400W peak pulse power capability with a 10/1000  $\mu$ s waveform, repetitive rate (duty cycle): 0.01%
3. Excellent clamping capability
4. Very fast response time
5. Low clamping voltage
6. Low leakage current
7. RoHS compliant
8. AEC-Q101 qualified



### ■ Recommended Applications

1. Computer
2. Telecom system
3. Industrial equipment
4. Consumer electronic device
5. Other VCC bus and I/O interfaces

### ■ Mechanical Data

1. Case: DO-41, molded plastic
2. Epoxy : UL 94V-0 rate flame retardant
3. Terminals: Solderable per MIL-STD-750, method 2026
4. Polarity: Color band denotes cathode end
5. Mounting Position: Any

### ■ Part Number Code

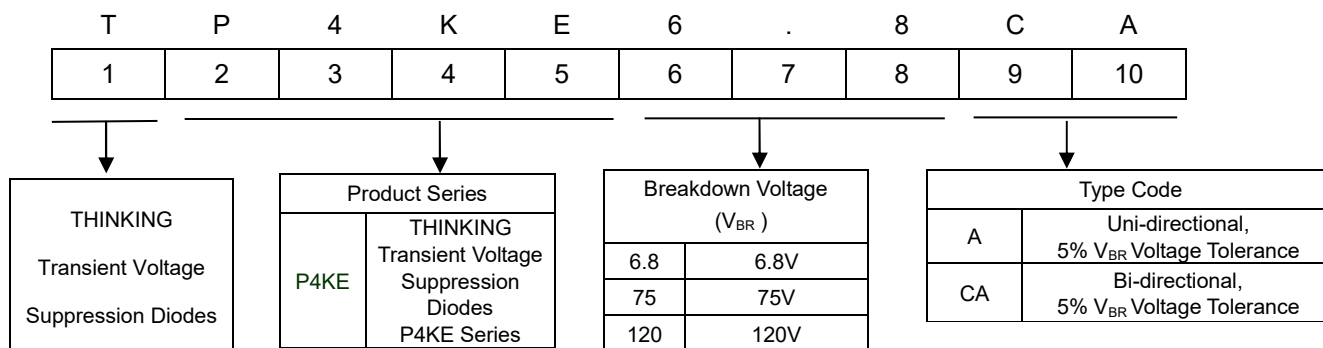

## SMD Type 400 W

### ■ Structures and Dimensions

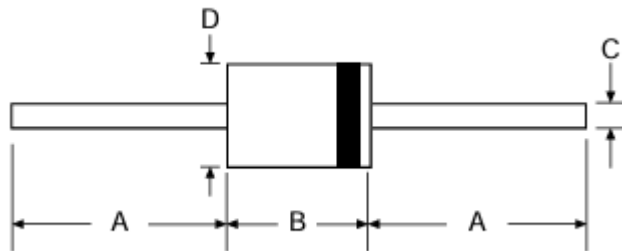

Symbol	Dimensions in millimeters	
	Min	Max
A	25.0	-
B	4.1	5.2
C	0.54	0.85
D	2.0	2.7

### ■ Maximum Rating ( $T_A=25^\circ\text{C}$ unless otherwise noted)

Parameter	Symbol	Value	Unit
Peak pulse power dissipation at $T_A=25^\circ\text{C}$ by 10/1000 $\mu\text{s}$ waveform (Note1)	$P_{PPM}$	400	W
Peak pulse current with 10/1000 $\mu\text{s}$ waveform (Note 1)	$I_{PPM}$	See next table	A
Peak forward surge current, 8.3ms single half sine wave on rated load (Note 2)	$I_{FSM}$	40	A
Power dissipation on infinite heatsink at $T_L=75^\circ\text{C}$	$P_D$	1.0	W
Typical thermal resistance junction to ambient	$R_{\theta JA}$	100	$^\circ\text{C/W}$
Typical thermal resistance junction to lead	$R_{\theta JL}$	60	$^\circ\text{C/W}$
Operating junction and storage temperature range	$T_J, T_{STG}$	-55~+150	$^\circ\text{C}$

Notes : (1) Non-repetitive current pulse, per Fig. 3 and derated above  $T_A=25^\circ\text{C}$  per Fig. 2

(2) Measured on 8.3ms single half sine wave or equivalent square wave for unidirectional device only, duty cycle=4 per minute maximum

# Transient Voltage Suppression Diodes: TP4KE Series

## SMD Type 400 W



### ■ Electrical Characteristics (T<sub>A</sub>=25°C unless otherwise noted)

Part No. (Uni)	Part No. (Bi)	Reverse Stand off Voltage	Breakage Voltage VBR @ IT		Test Current IT( mA )	Maximum Clamping Voltage VC @ Ipp	Maximum Peak Pulse Current Ipp(A)	Maximum Reverse Leakage IR @VRWM
			VRWM ( V )	Min( V )				
TP4KE6.8A	TP4KE6.8CA	5.8	6.45	7.14	10	10.5	39	1000
TP4KE7.5A	TP4KE7.5CA	6.4	7.13	7.88	10	11.3	36.3	500
TP4KE8.2A	TP4KE8.2CA	7.02	7.79	8.61	10	12.1	33.9	200
TP4KE9.1A	TP4KE9.1CA	7.78	8.65	9.55	1	13.4	30.6	50
TP4KE10A	TP4KE10CA	8.55	9.5	10.5	1	14.5	28.3	10
TP4KE11A	TP4KE11CA	9.4	10.5	11.6	1	15.6	26.3	5
TP4KE12A	TP4KE12CA	10.2	11.4	12.6	1	16.7	24.6	5
TP4KE13A	TP4KE13CA	11.1	12.4	13.7	1	18.2	22.5	1
TP4KE15A	TP4KE15CA	12.8	14.3	15.8	1	21.2	19.3	1
TP4KE16A	TP4KE16CA	13.6	15.2	16.8	1	22.5	18.2	1
TP4KE18A	TP4KE18CA	15.3	17.1	18.9	1	25.2	16.1	1
TP4KE20A	TP4KE20CA	17.1	19	21	1	27.7	14.8	1
TP4KE22A	TP4KE22CA	18.8	20.9	23.1	1	30.6	13.4	1
TP4KE24A	TP4KE24CA	20.5	22.8	25.2	1	33.2	12.3	1
TP4KE27A	TP4KE27CA	23.1	25.7	28.4	1	37.5	10.9	1
TP4KE30A	TP4KE30CA	25.6	28.5	31.5	1	41.4	9.9	1
TP4KE33A	TP4KE33CA	28.2	31.4	34.7	1	45.7	9	1
TP4KE36A	TP4KE36CA	30.8	34.2	37.8	1	49.9	8.2	1
TP4KE39A	TP4KE39CA	33.3	37.1	41	1	53.9	7.6	1
TP4KE43A	TP4KE43CA	36.8	40.9	45.2	1	59.3	6.9	1
TP4KE47A	TP4KE47CA	40.2	44.7	49.4	1	64.8	6.3	1
TP4KE51A	TP4KE51CA	43.6	48.5	53.6	1	70.1	5.8	1
TP4KE56A	TP4KE56CA	47.8	53.2	58.8	1	77	5.3	1
TP4KE62A	TP4KE62CA	53	58.9	65.1	1	85	4.8	1
TP4KE68A	TP4KE68CA	58.1	64.6	71.4	1	92	4.5	1
TP4KE75A	TP4KE75CA	64.1	71.3	78.8	1	103	4	1
TP4KE82A	TP4KE82CA	70.1	77.9	86.1	1	113	3.6	1
TP4KE91A	TP4KE91CA	77.8	86.5	95.5	1	125	3.3	1
TP4KE100A	TP4KE100CA	85.5	95	105	1	137	3	1
TP4KE110A	TP4KE110CA	94	105	116	1	152	2.7	1
TP4KE120A	TP4KE120CA	102	114	126	1	165	2.5	1
TP4KE130A	TP4KE130CA	111	124	137	1	179	2.3	1

# Transient Voltage Suppression Diodes: TP4KE Series



## SMD Type 400 W

### ■ Electrical Characteristics (T<sub>A</sub>=25°C unless otherwise noted)

Part No. (Uni)	Part No. (Bi)	Reverse Stand off Voltage	Breakage Voltage VBR @ IT		Test Current IT( mA )	Maximum Clamping Voltage VC @ Ipp	Maximum Peak Pulse Current Ipp(A)	Maximum Reverse Leakage IR @VRWM
			VRWM ( V )	Min( V )				
TP4KE150A	TP4KE150CA	128	143	158	1	207	2	1
TP4KE160A	TP4KE160CA	136	152	168	1	219	1.9	1
TP4KE170A	TP4KE170CA	145	162	179	1	234	1.8	1
TP4KE180A	TP4KE180CA	154	171	189	1	246	1.7	1
TP4KE200A	TP4KE200CA	171	190	210	1	274	1.5	1
TP4KE220A	TP4KE220CA	185	209	231	1	328	1.3	1
TP4KE250A	TP4KE250CA	214	237	263	1	344	1.2	1
TP4KE300A	TP4KE300CA	256	285	315	1	414	1	1
TP4KE350A	TP4KE350CA	300	332	368	1	482	0.9	1
TP4KE400A	TP4KE400CA	342	380	420	1	548	0.8	1
TP4KE440A	TP4KE440CA	376	418	462	1	602	0.7	1
TP4KE480A	TP4KE480CA	408	456	504	1	658	0.6	1
TP4KE510A	TP4KE510CA	434	485	535	1	698	0.6	1
TP4KE530A	TP4KE530CA	450	503.5	556.5	1	725	0.6	1
TP4KE540A	TP4KE540CA	459	513	567	1	740	0.5	1
TP4KE550A	TP4KE550CA	467	522.5	557.5	1	760	0.5	1

## SMD Type 400 W

### ■ Rate and Characteristic Curve ( $T_A=25^\circ\text{C}$ unless otherwise noted)

Fig.1 - Peak Pulse Power Rating Curve

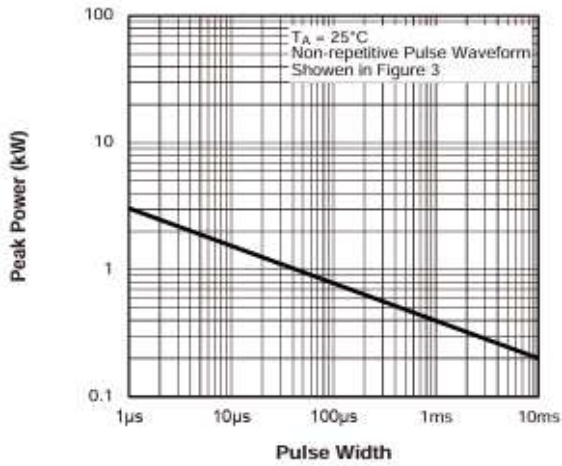

Fig.2 - Pulse Derating Curve

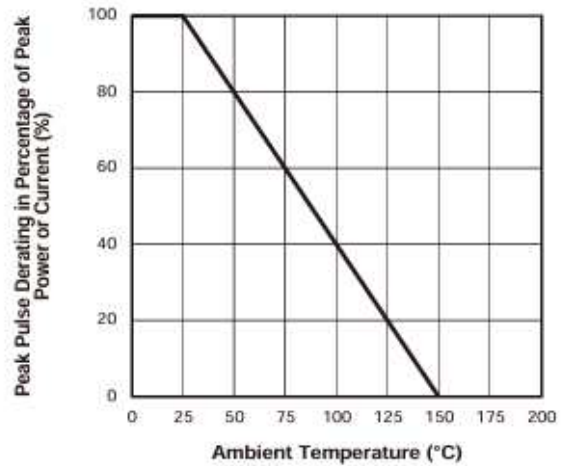

Fig.3 - Pulse Waveform

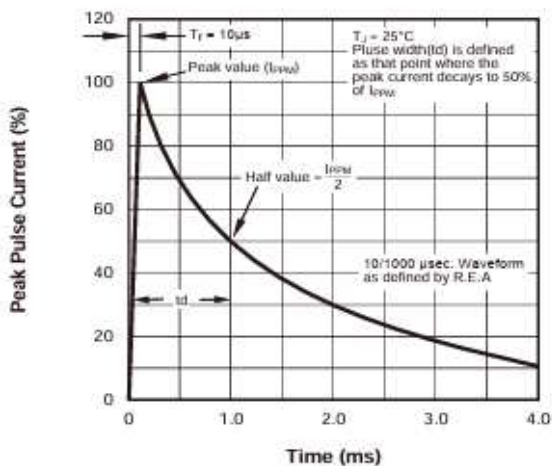
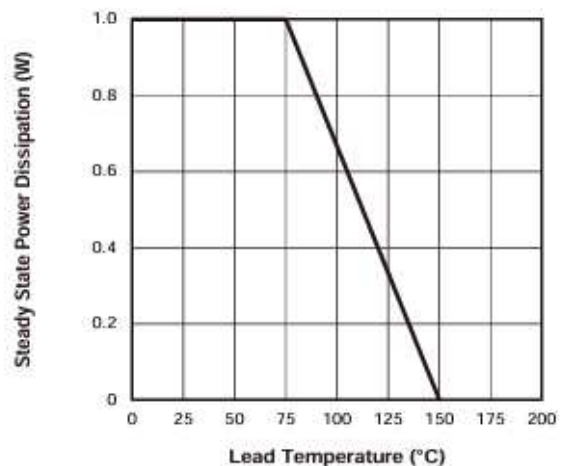
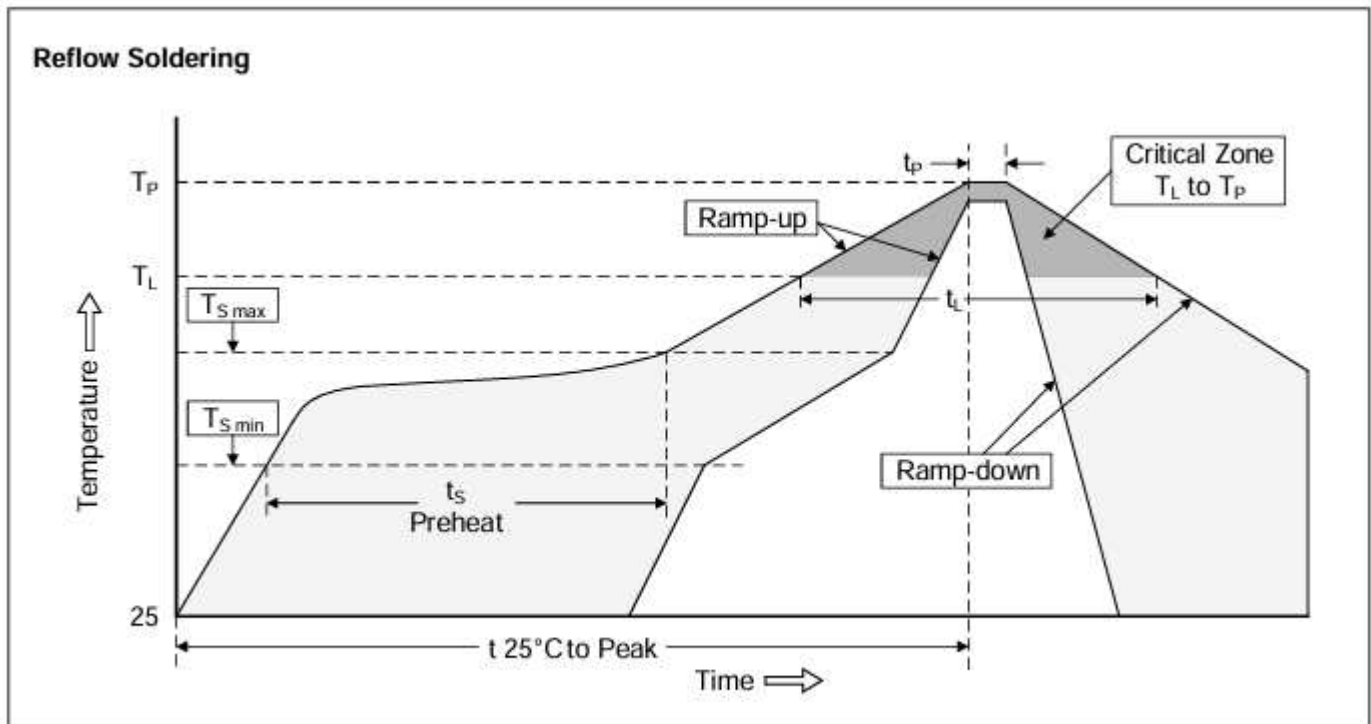

Fig.4 - Steady State Power Derating Curve



## SMD Type 400 W

### IR-reflow soldering profile



### Recommended Conditions

Profile Feature	Pb-Free Assembly
Average ramp-up rate (T <sub>L</sub> to T <sub>P</sub> )	3°C/second max.
Preheat -Temperature Min (T <sub>S min</sub> ) -Temperature Max (T <sub>S max</sub> ) -Time (min to max) (t <sub>S</sub> )	150°C 200°C 60-180 seconds
T <sub>S max</sub> to T <sub>L</sub> -Ramp-up Rate	3°C/second max.
Time maintained above: -Temperature (T <sub>L</sub> ) -Time (t <sub>L</sub> )	217°C 60-150 seconds
Peak Temperature (T <sub>P</sub> )	260°C
Time within 5°C of actual Peak Temperature (t <sub>P</sub> )	20-40 seconds
Ramp-down Rate	6°C/second max.
Time 25°C to Peak Temperature	8 minutes max.

# Transient Voltage Suppression Diodes: TP4KE Series

## SMD Type 400 W



### ■ Quantity

Series Type	Packaging option	Base quantity	Packaging specification
TP4KE	Tape and box	5000	EIA STD RS-481

### ■ Warehouse Storage Conditions of product

- Storage Condition:
  1. Storage Temperature:  $\leq 25^{\circ}\text{C}$
  2. Relative Humidity: 50%~80%RH
  3. Keep away from corrosive atmosphere and sunlight.
- Period of Storage: 1 year.