

Features

- 50Watts peak pulse power ($t_p = 8/20\mu s$)
- DFN0603-2 package
- Bidirectional configurations
- Solid-state silicon-avalanche technology
- Low clamping voltage
- Low leakage current
- Medium capacitance ($C_J=0.2pF$ typ.)
- Protection one data/power line to:
IEC 61000-4-2 $\pm 18kV$ contact $\pm 18kV$ air
IEC 61000-4-4 (EFT) 40A (5/50ns)
IEC 61000-4-5 (Lightning) 7A (8/20 μs)

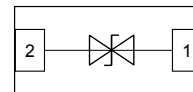

Mechanical Data

- **Case:** DFN0603-2 (plastic package).
Lead free; RoHS compliant; Halogen free
- **Molding Compound Flammability Rating:**
UL 94 V-0
- **Terminals:** High temperature soldering guaranteed:
260 °C/10 sec. at terminals

Applications

- Cell Phone Handsets and Accessories
- Personal Digital Assistants (PDA's)
- Microprocessor based equipment
- Notebooks, Desktops, and Servers
- Portable Instrumentation

Absolute Maximum Ratings

Ratings at 25 °C, ambient temperature unless otherwise specified

Parameter	Symbol	Value	Unit
Peak Pulse Power ($T_P=8/20\mu S$)	P_{PP}	50	W
ESD contact/air discharge (IEC-61000-4-2)	V_{ESD}	18/18	kV
Peak Pulse Current ($t_p = 8/20\mu S$)	I_{PP}	7	A
Junction Temperature	T_J	-55 to +125	°C
Storage temperature	T_{STG}	-55 to +150	°C

Electrical Characteristics

($T_A = 25$ °C unless otherwise specified)

Parameter	Symbol	Condition	Min	Typ	Max	Unit
Reverse stand-off Voltage	V_{RWM}				3.3	V
Holding Voltage	V_H	$I_T=I_H$	2.0		5.0	V
Holding Current	I_H		15			mA
Reverse Leakage Current	I_R	$V_{RWM}=5V$			500	nA
Clamping Voltage	V_C	$I_{PP}=7A, t_p=8/20\mu s$		6.0	7.5	V
Clamping Voltage(TLP)	V_C	$I_{PP}=16A, T_P=100ns$		7.0		V
Trigger Voltage	V_T		8		16	V
Dynamic Resistance	R_{dyn}	$T_P=100ns$		0.25		Ω
Junction Capacitance	C_J	$V_R=0V, f=1MHz$		0.20	0.50	pF

Typical Characteristics ($T_{amb} = 25\text{ }^{\circ}\text{C}$ unless otherwise specified)

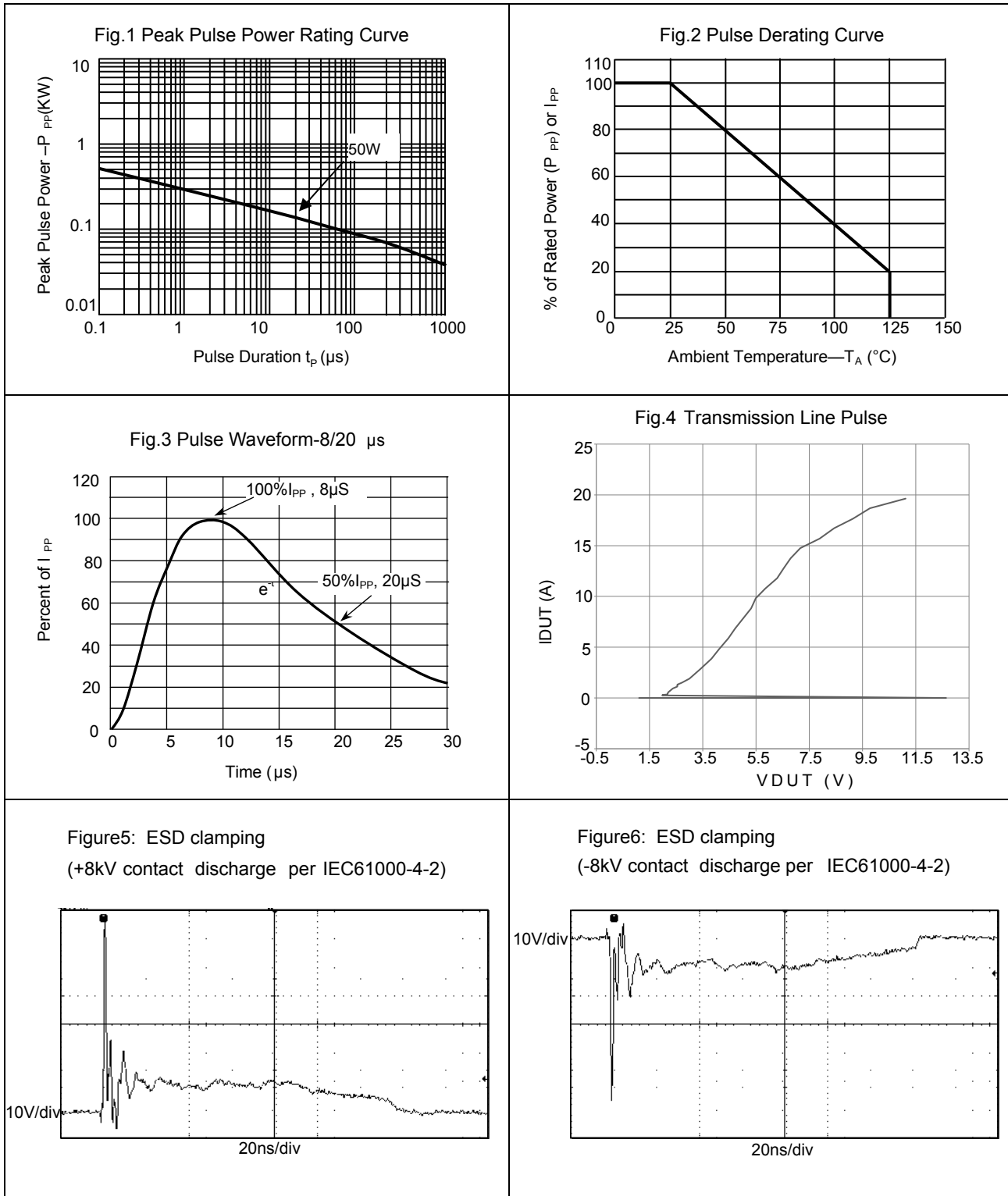

Package Dimensions

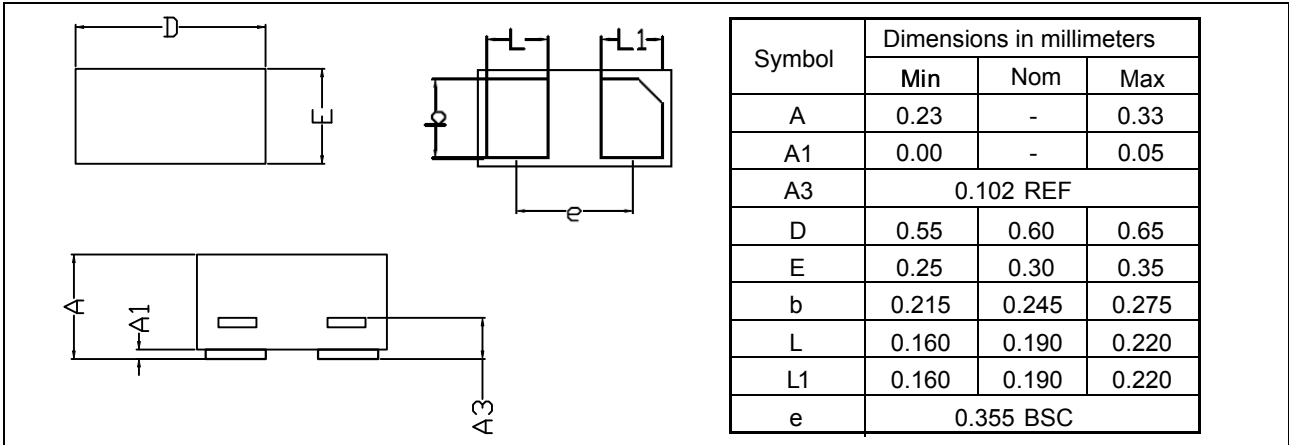

Pad Dimensions

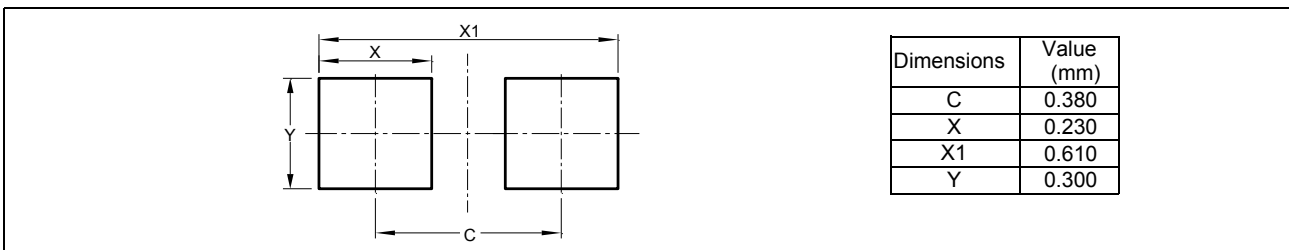

Package Information

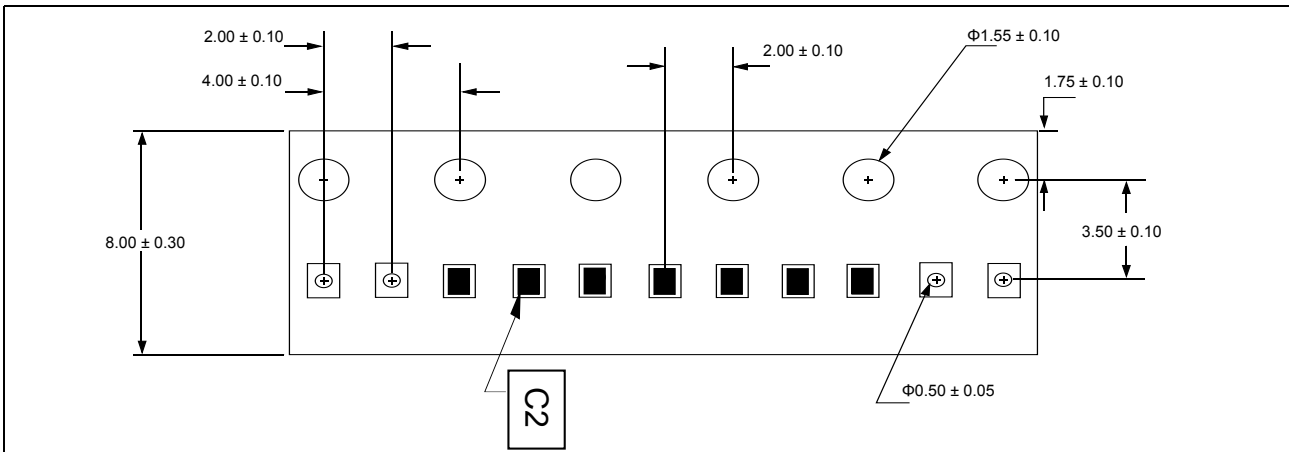

Ordering information

Order code	Marking	Package	Packaging option	Base quantity	Packaging specification
YEUD0623R07AB	C2	DFN0603-2	Tape and reel	10000pcs / reel	EIA STD RS-481