

■ Features

1. Glass Passivated Junction technology
2. Both available in uni and bi-polar directional polarity
3. Low leakage current
4. Low forward voltage drop for uni-directional polarity
5. High surge capability
6. $T_J = 175^{\circ}\text{C}$ capability suitable for high reliability
7. Meets ISO7637-2 & ISO16750-2 surge specification (varied by test condition)
8. Halogen free
9. RoHS compliant
10. AEC-Q101 qualified



■ Recommended Applications

Use in sensitive electronics protection against voltage transients induced by inductive load switching and lighting, especially for automotive load dump protection application.

■ Mechanical Data

1. Case: Molded plastic, DO-218AB
2. Epoxy: UL 94V-0 rate flame retardant
3. Terminals: Solderable per MIL-STD-750, method 2026
4. Polarity: Heatsink is anode
5. Mounting Position: Any

■ Part Number Code

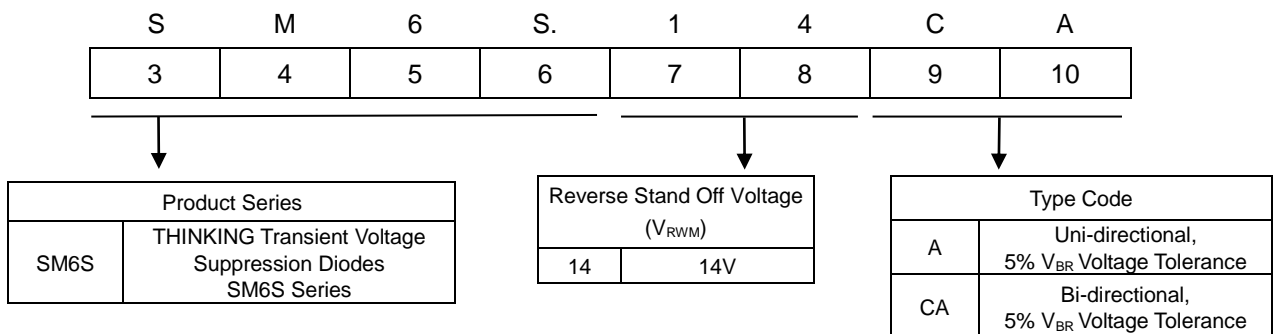

Structures and Dimensions

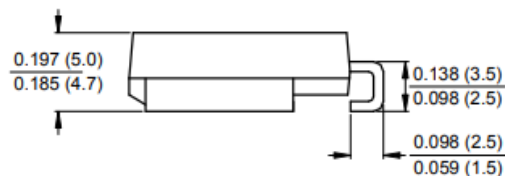
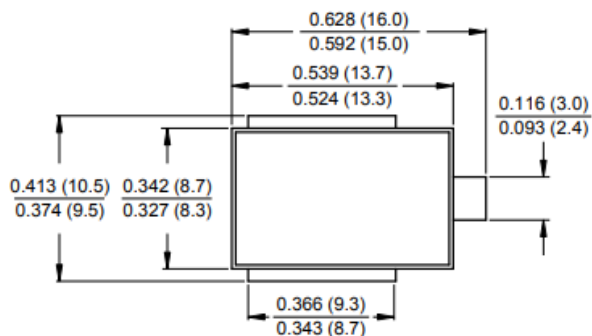

Dimensions in inches and (millimeters)

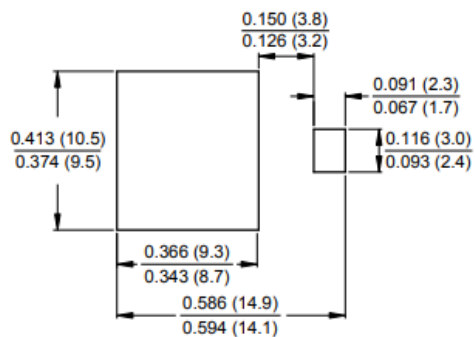

Dimensions in inches and (millimeters)

Maximum Rating ($T_A=25^\circ\text{C}$ unless otherwise noted)

Parameter	Symbol	Value	Unit
Peak power dissipation @10/1000 μs waveform	P_{PPM}	4600	W
Peak forward surge current, 8.3 ms single half sine-wave (Note 1)	I_{FSM}	600	A
Peak pulse current with 10/1000 μs waveform (Note 2)	I_{PPM}	See next table	A
Power dissipation on infinite heatsink at $T_C=25^\circ\text{C}$ (Fig.1)	P_D	6.0	W
Maximum instantaneous forward voltage at 100A for unidirectional only	V_F	1.8	V
Operating junction and storage temperature range	T_J, T_{STG}	-55~+175	$^\circ\text{C}$

Notes : (1) Measured on 8.3ms single half sine wave or equivalent square wave for unidirectional device only, duty cycle=4 per minute maximum

(2) Non-repetitive current pulse derated above $T_A=25^\circ\text{C}$

■ Electrical Characteristics (T_A=25°C unless otherwise noted)

Part No. (Uni)	Part No. (Bi)	Reverse Stand off Voltage V _{RWM} (V)	Breakage Voltage V _{BR} @ I _T		Test Current I _T (mA)	Maximum Clamping Voltage V _C @ I _{pp} V _C (V)	Maximum Peak Pulse Current I _{pp} (A)	Maximum Reverse Leakage I _R @ V _{RWM} I _R (μA)
			Min(V)	Max(V)				
SM6S16A	SM6S16CA	16	17.8	19.7	5	26	177	10
SM6S17A	SM6S17CA	17	18.9	20.9	5	27.6	166.7	10
SM6S18A	SM6S18CA	18	20	22.1	5	29.2	157.5	10
SM6S20A	SM6S20CA	20	22.2	24.5	5	32.4	142	10
SM6S22A	SM6S22CA	22	24.4	26.9	5	35.5	129.6	10
SM6S24A	SM6S24CA	24	26.7	29.5	5	38.9	118.3	10
SM6S26A	SM6S26CA	26	28.9	31.9	5	42.1	109.3	10
SM6S28A	SM6S28CA	28	31.1	34.4	5	45.4	101.3	10
SM6S30A	SM6S30CA	30	33.3	36.8	5	48.4	95	10
SM6S33A	SM6S33CA	33	36.7	40.6	5	53.3	86.3	10
SM6S36A	SM6S36CA	36	40	44.2	5	58.1	79.2	10
SM6S40A	SM6S40CA	40	44.4	49.1	5	64.5	71.3	10
SM6S43A	SM6S43CA	43	47.8	52.8	5	69.4	66.3	10

■ Rate and Characteristic Curve ($T_A=25^\circ\text{C}$ unless otherwise noted)

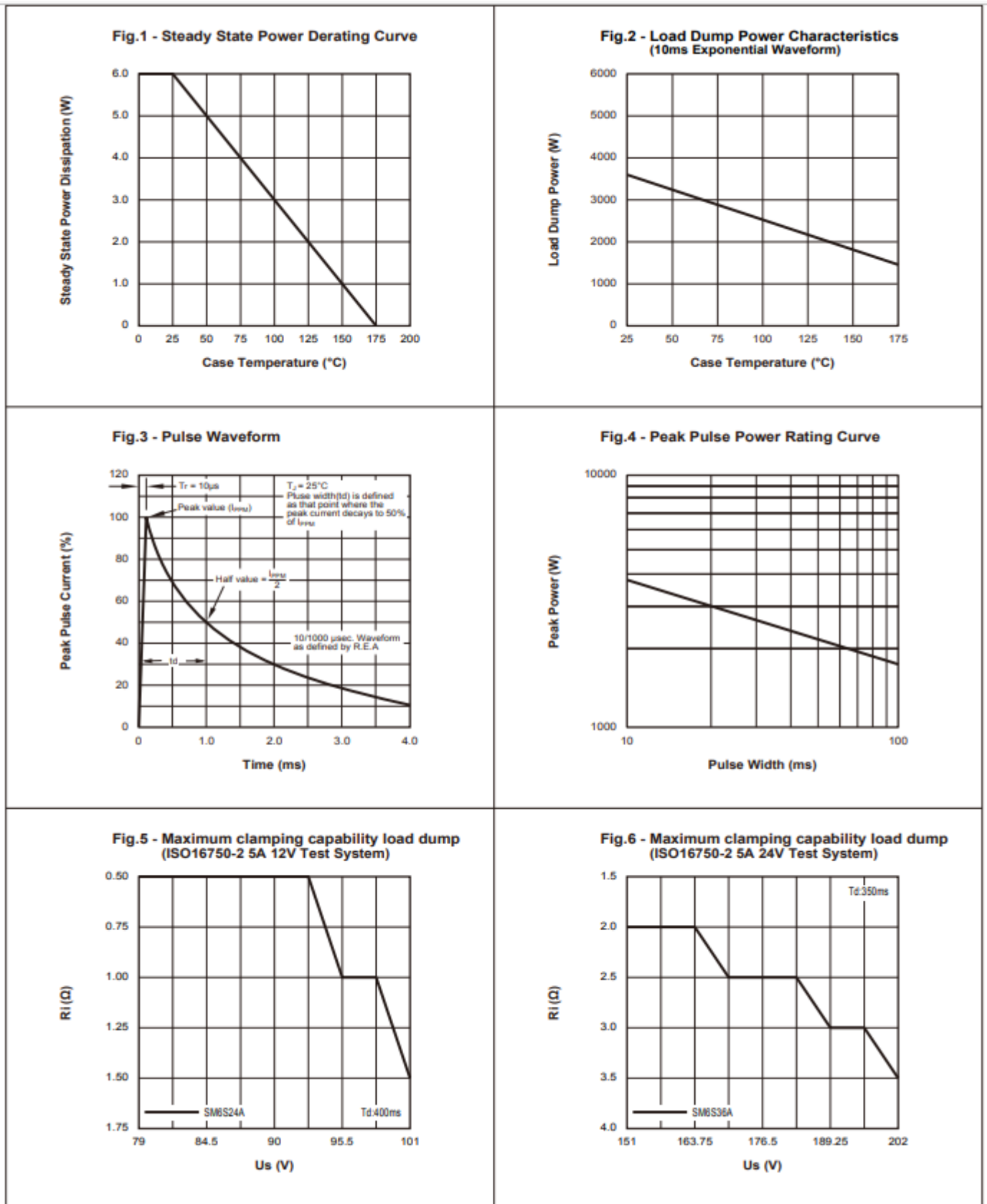

IR-reflow soldering profile

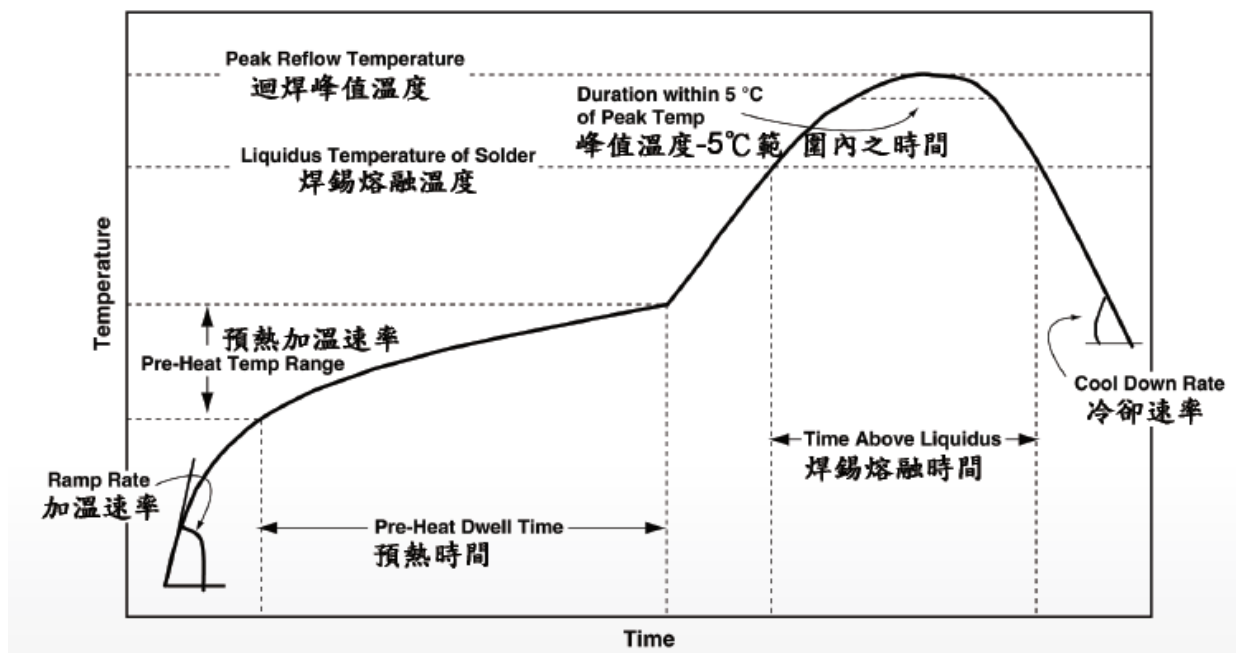

LEAD(Pb)-FREE SOLDER(SnAgCu) REFLOW PROFILE ATTRIBUTES

PROFILE ATTRIBUTE	PROFILE ATTRIBUTE
Peak Reflow Temperature	260(+8/-8)°C
Time within 5°C of Peak Temperature	30s max
Liquidus Temperature of Solder	217°C
Cool Down Rate	6 °C/s max
Time above Liquidus	60s to 150s
Pre-heat Temperature Range	150°C to 200°C
Pre-heat Dwell Time	60s to 120s
Maximum Ramp Rate	3 °C/s max

■ Packaging

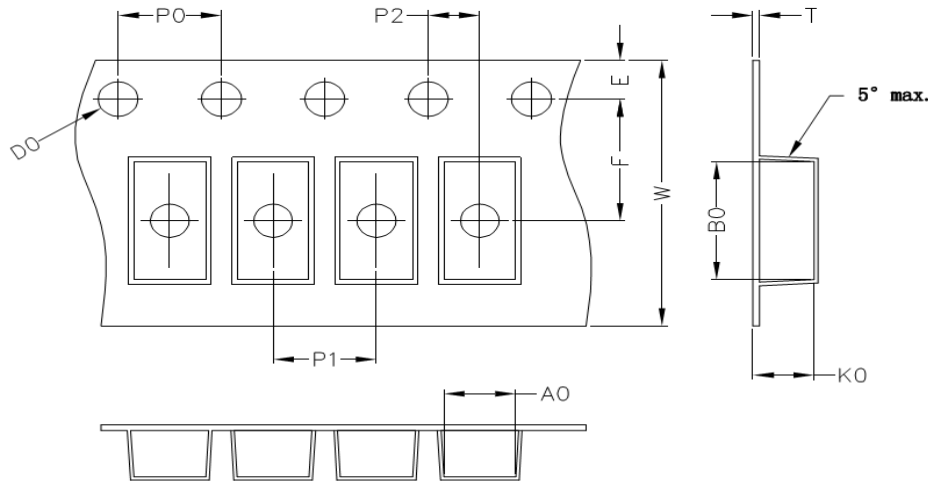

(Unit : mm)

Index	A0	B0	K0	D0	E	F	P0	P1	P2	T	W
SM6S	10.6	15.9	5.85	1.5	1.75	11.5	4	16	2	0.35	24

■ Quantity

Series Type	Packaging option	Base quantity	Packaging specification
SM6S	Tape & Reel - 24mm/13" tape	750	EIA STD RS-481

■ Warehouse Storage Conditions of product

- Storage Condition:
 1. Storage Temperature: $\leq 25^{\circ}\text{C}$
 2. Relative Humidity: 50%~80%RH
 3. Keep away from corrosive atmosphere and sunlight.
- Period of Storage: 1 year.