

TVS Diode: SMAF Series

SMD Low Profile Type 400 W



■ Features

1. Glass passivated chip
2. 400W peak pulse power capability at 10/1000 μ s waveform, repetition rate (duty cycle): 0.01%
3. Excellent clamping capability
4. Very fast response time
5. Low clamping voltage
6. Low leakage current
7. Meets MSL level 1, per J-STD-020, LF maximum peak of 260°C
8. JESD22-A114-B ESD Voltage: HBM 15KV
9. JEDEC EIA/JESD22-C101F ESD Voltage: CDM 500V
10. JEDEC EIA/JESD22-A115 ESD Voltage: MM 400V
11. ESD-immunity acc. IEC 61000-4-2 \pm 30kV(contact), \pm 30kV(air)
12. Halogen free and RoHS compliant

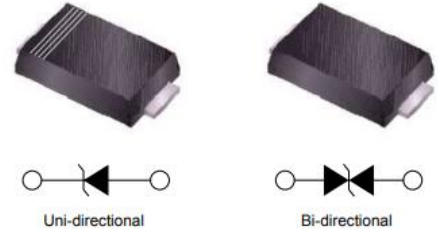

■ Recommended Applications

1. Computers
2. Telecom system
3. Industrial equipment
4. Consumer electronic applications
5. Other VCC bus and I/O interfaces

■ Mechanical Data

1. Case: Molded plastic, SMA-FL
2. Epoxy: UL 94V-0 rate flame retardant
3. Terminals: Solderable per MIL-STD-750, method 2026
4. Polarity: Color band denotes cathode end
5. Mounting Position: Any

■ Part Number Code

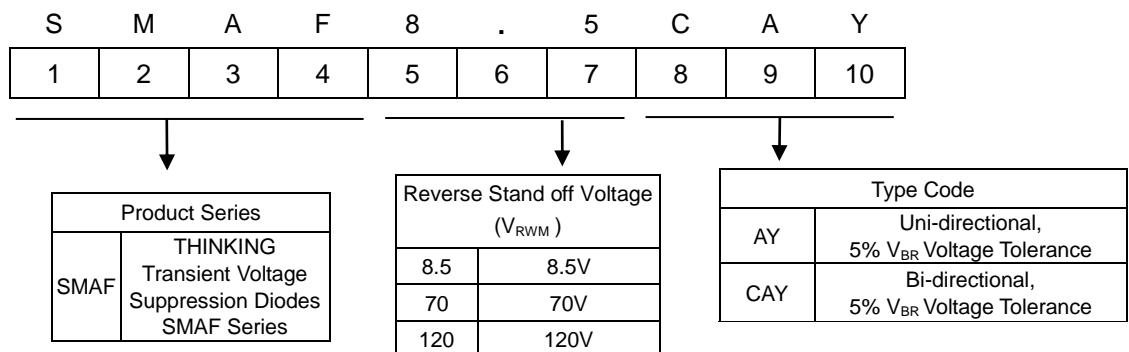

TVS Diode: SMAF Series

SMD Low Profile Type 400 W



Structures and Dimensions

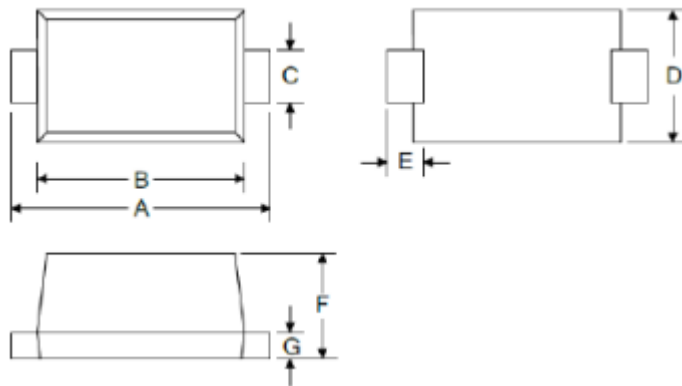

Symbol	Dimensions in millimeters	
	Min	Max
A	4.4	4.9
B	3.3	3.7
C	1.3	1.6
D	2.4	2.7
E	0.8	1.2
F	0.9	1.2
G	0.12	0.2

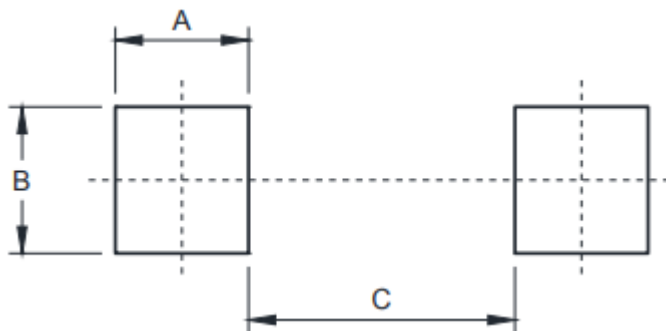

Symbol	Unit (mm)	Unit (inch)
A	1.6	0.063
B	1.8	0.071
C	2.2	0.087

Maximum Rating (TA=25°C unless otherwise noted)

Parameter	Symbol	Value	Unit
Peak power dissipation with a 10/1000μs waveform (Note 1,2)	P _{PPM}	400	W
Peak pulse current with 10/1000 μs waveform (Note 1)	I _{PPM}	See next table	A
Peak forward surge current, 8.3 ms single half sine-wave (Note 3)	I _{FSM}	40	A
Power dissipation on infinite heatsink at T _L =75°C	P _D	3.3	W
Typical thermal resistance junction to ambient	R _{θJA}	120	°C/W
Typical thermal resistance junction to lead	R _{θJL}	30	°C/W
Operating junction and storage temperature range	T _J , T _{STG}	-55 to +150	°C

Note:

1. Non-repetitive current pulse, per Fig. 3 and derated above T_A=25°C per Fig. 2.
2. Mounted on 5.0 x 5.0mm copper pad to each terminal.
3. Measured on 8.3ms single half sine wave or equivalent square wave for unidirectional device only, duty cycle=4 per minute maximum.

TVS Diode: SMAF Series

SMD Low Profile Type 400 W



■ Electrical Characteristics (T_A=25°C unless otherwise noted)

Part No. (Uni)	Part No. (Bi)	Reverse Stand off Voltage	Breakage Voltage V _{BR} @ I _T		Test Current I _T (mA)	Maximum Clamping Voltage V _C @ I _{pp}	Maximum Peak Pulse Current I _{pp} (A)	Maximum Reverse Leakage I _R @ V _{RWM}	Marking Code	
			V _{RWM} (V)	Min (V)					Max (V)	Uni
SMAF5.0AY	SMAF5.0CAY	5	6.4	7.07	10	9.2	43.48	400	AE	WE
SMAF6.0AY	SMAF6.0CAY	6	6.67	7.37	10	10.3	38.83	400	AG	WG
SMAF6.5AY	SMAF6.5CAY	6.5	7.22	7.98	10	11.2	35.71	250	AK	WK
SMAF7.0AY	SMAF7.0CAY	7	7.78	8.6	10	12	33.33	100	AM	WM
SMAF7.5AY	SMAF7.5CAY	7.5	8.33	9.21	1	12.9	31.01	50	AP	WP
SMAF8.0AY	SMAF8.0CAY	8	8.89	9.83	1	13.6	29.41	25	AR	WR
SMAF8.5AY	SMAF8.5CAY	8.5	9.44	10.4	1	14.4	27.78	5	AT	WT
SMAF9.0AY	SMAF9.0CAY	9	10	11.1	1	15.4	25.97	5	AV	WV
SMAF10AY	SMAF10CAY	10	11.1	12.3	1	17	23.53	5	AX	WX
SMAF11AY	SMAF11CAY	11	12.2	13.5	1	18.2	21.98	1	AZ	WZ
SMAF12AY	SMAF12CAY	12	13.3	14.7	1	19.9	20.1	1	BE	XE
SMAF13AY	SMAF13CAY	13	14.4	15.9	1	21.5	18.6	1	BG	XG
SMAF14AY	SMAF14CAY	14	15.6	17.2	1	23.2	17.24	1	BK	XK
SMAF15AY	SMAF15CAY	15	16.7	18.5	1	24.4	16.39	1	BM	XM
SMAF16AY	SMAF16CAY	16	17.8	19.7	1	26	15.38	1	BP	XP
SMAF17AY	SMAF17CAY	17	18.9	20.9	1	27.6	14.49	1	BR	XR
SMAF18AY	SMAF18CAY	18	20	22.1	1	29.2	13.7	1	BT	XT
SMAF19AY	SMAF19CAY	19	21.1	23.3	1	30.8	13	1	BW	XW
SMAF20AY	SMAF20CAY	20	22.2	24.5	1	32.4	12.35	1	BV	XV
SMAF22AY	SMAF22CAY	22	24.4	26.9	1	35.5	11.27	1	BX	XX
SMAF24AY	SMAF24CAY	24	26.7	29.5	1	38.9	10.28	1	BZ	XZ
SMAF26AY	SMAF26CAY	26	28.9	31.9	1	42.1	9.5	1	CE	YE
SMAF28AY	SMAF28CAY	28	31.1	34.4	1	45.4	8.81	1	CG	YG
SMAF30AY	SMAF30CAY	30	33.3	36.8	1	48.4	8.26	1	CK	YK
SMAF33AY	SMAF33CAY	33	36.7	40.6	1	53.3	7.5	1	CM	YM
SMAF36AY	SMAF36CAY	36	40	44.2	1	58.1	6.88	1	CP	YP
SMAF40AY	SMAF40CAY	40	44.4	49.1	1	64.5	6.2	1	CR	YR
SMAF43AY	SMAF43CAY	43	47.8	52.8	1	69.4	5.76	1	CT	YT
SMAF45AY	SMAF45CAY	45	50	55.3	1	72.7	5.5	1	CV	YV
SMAF48AY	SMAF48CAY	48	53.3	58.9	1	77.4	5.17	1	CX	YX

TVS Diode: SMAF Series

SMD Low Profile Type 400 W



■ Electrical Characteristics (T_A=25°C unless otherwise noted)

Part No. (Uni)	Part No. (Bi)	Reverse Stand off Voltage	Breakage Voltage V _{BR} @ I _T		Test Current I _T (mA)	Maximum Clamping Voltage V _C @ I _{pp}	Maximum Peak Pulse Current I _{pp} (A)	Maximum Reverse Leakage I _R @ V _{RWM}	Marking Code	
			V _{RWM} (V)	Min(V)					Max(V)	Uni
SMAF51AY	SMAF51CAY	51	56.7	62.7	1	82.4	4.85	1	CZ	YZ
SMAF54AY	SMAF54CAY	54	60	66.3	1	87.1	4.59	1	RE	ZE
SMAF58AY	SMAF58CAY	58	64.4	71.2	1	93.6	4.27	1	RG	ZG
SMAF60AY	SMAF60CAY	60	66.7	73.7	1	96.8	4.13	1	RK	ZK
SMAF64AY	SMAF64CAY	64	71.1	78.6	1	103	3.88	1	RM	ZM
SMAF70AY	SMAF70CAY	70	77.8	86	1	113	3.54	1	RP	ZP
SMAF75AY	SMAF75CAY	75	83.3	92.1	1	121	3.31	1	RR	ZR
SMAF78AY	SMAF78CAY	78	86.7	95.8	1	126	3.17	1	RT	ZT
SMAF80AY	SMAF80CAY	80	88.8	97.6	1	129.6	3.09	1	RW	ZW
SMAF85AY	SMAF85CAY	85	94.4	104	1	137	2.92	1	RV	ZV
SMAF90AY	SMAF90CAY	90	100	111	1	146	2.74	1	RX	ZX
SMAF100AY	SMAF100CAY	100	111	123	1	162	2.47	1	RZ	ZZ
SMAF110AY	SMAF110CAY	110	122	135	1	177	2.26	1	SE	VE
SMAF120AY	SMAF120CAY	120	133	147	1	193	2.07	1	SG	VG
SMAF130AY	SMAF130CAY	130	144	159	1	209	1.91	1	SK	VK
SMAF140AY	SMAF140CAY	140	155	171	1	226.8	1.76	1	SW	VW
SMAF150AY	SMAF150CAY	150	167	185	1	243	1.65	1	SM	VM
SMAF160AY	SMAF160CAY	160	178	197	1	259	1.54	1	SP	VP
SMAF170AY	SMAF170CAY	170	189	209	1	275	1.45	1	SR	VR
SMAF180AY	SMAF180CAY	180	200	220	1	291.6	1.37	1	ST	VT
SMAF190AY	SMAF190CAY	190	211	232	1	307.8	1.3	1	SU	VU
SMAF200AY	SMAF200CAY	200	224	247	1	324	1.23	1	SV	VV

TVS Diode: SMAF Series

SMD Low Profile Type 400 W



■ Typical Characteristics ($T_A=25^\circ\text{C}$ unless otherwise noted)

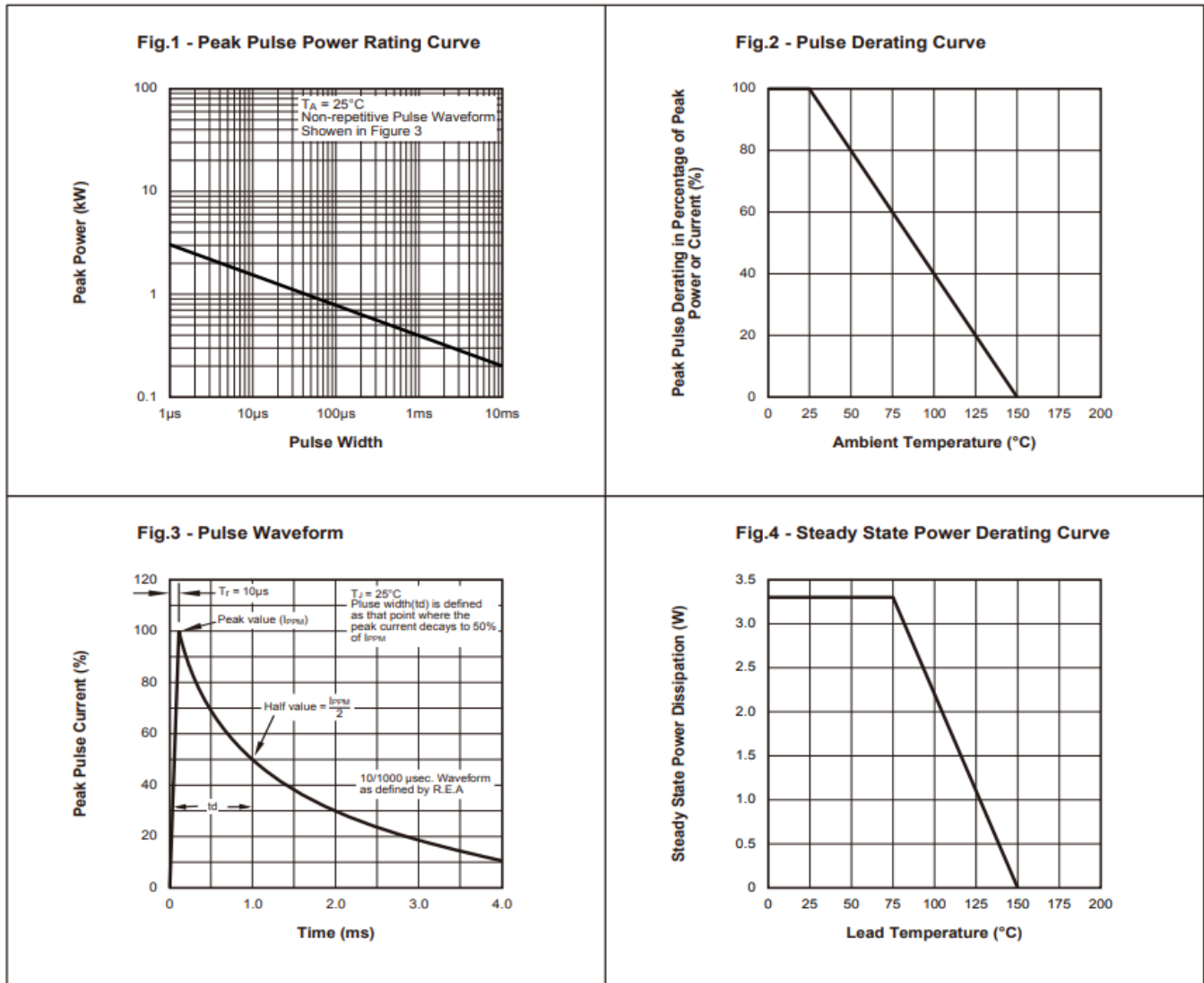

TVS Diode: SMAF Series

SMD Low Profile Type 400 W



■ Soldering Recommendation

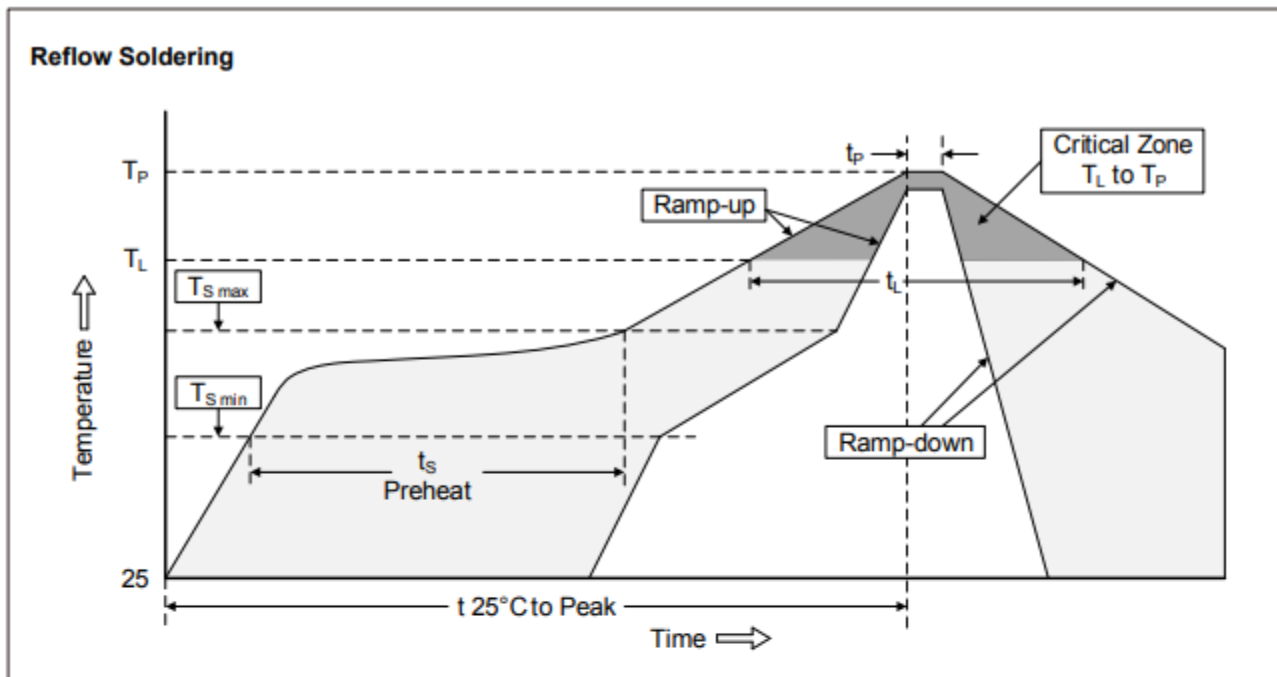

Recommended Conditions

Profile Feature	Pb-Free Assembly
Average ramp-up rate (T_L to T_P)	3°C/second max.
Preheat	
-Temperature Min ($T_{S\min}$)	150°C
-Temperature Max ($T_{S\max}$)	200°C
-Time (min to max) (t_s)	60-180 seconds
$T_{S\max}$ to T_L	
-Ramp-up Rate	3°C/second max.
Time maintained above:	
-Temperature (T_L)	217°C
-Time (t_L)	60-150 seconds
Peak Temperature (T_P)	260°C
Time within 5°C of actual Peak Temperature (t_p)	20-40 seconds
Ramp-down Rate	6°C/second max.
Time 25°C to Peak Temperature	8 minutes max.

TVS Diode: SMAF Series

SMD Low Profile Type 400 W



■ Packaging

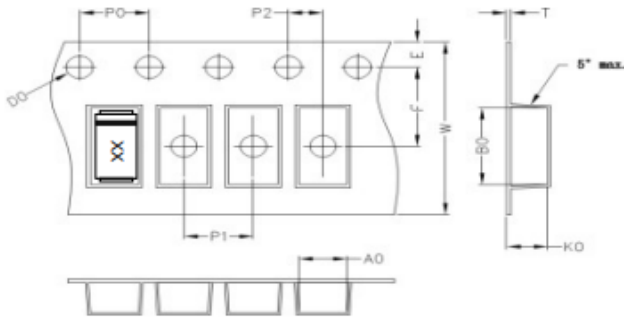

A0	B0	K0	D0	E	F
2.83	4.75	1.42	1.55	1.75	5.50
P0	P1	P2	T	W	Tolerance
4.0	4.0	2.0	0.25	12	0.1

■ Quantity

Series Type	Packaging option	Base quantity	Packaging specification
SMAF	Tape and reel	3000pcs / reel	EIA STD RS-481

■ Warehouse Storage Conditions of product

- Storage Condition:
 - Storage Temperature: $-10^{\circ}\text{C} \sim +40^{\circ}\text{C}$
 - Relative Humidity: $\leq 75\% \text{RH}$
 - Keep away from corrosive atmosphere and sunlight.
- Period of Storage: 1 year.