

# Varistor: TVA22 Series



## Strap Type Varistor for Over-Voltage Protection

### ■ Features

1. RoHS & halogen-free compliant
2. Body size: 22\*25mm
3. Agency recognition: UL
4. UL 1449 4th for SPD Type 5 application

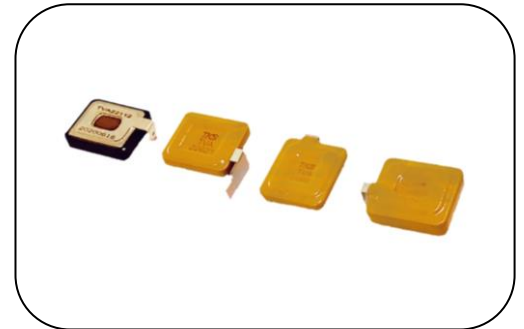

### ■ Recommended Applications

1. EV charging station
2. Inverter
3. Telecommunications
4. AC/DC circuit
5. PV applications
6. SPD (Surge Protection Device)

### ■ Part Number Code

T	V	A	2	2	2	0	1	K	K	Q	B	J				
1	2	3	4	5	6	7	8	9	10	11	12	13	14	15	16	
Product Type		Size		Varistor Voltage (V <sub>1mA</sub> )		Tolerance of V <sub>1mA</sub>		Structure		Optional Suffix						
TVA	THINKING Varistor TVA Series	22	22*25mm	820	82V	K	±10%	AAAA~ZZZZ	001~999							
				201	200V											
				102	1000V											

# Varistor: TVA22 Series

## Strap Type Varistor for Over-Voltage Protection



### Structures and Dimensions

#### ● KQAP Type

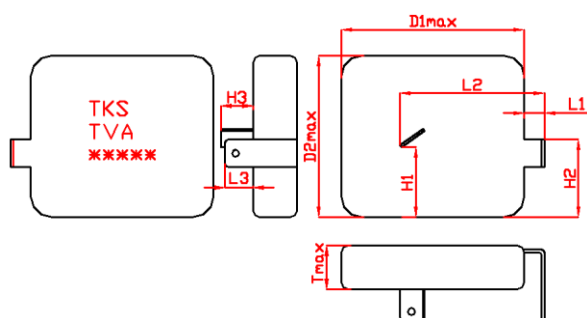

#### ● KQBJ Type

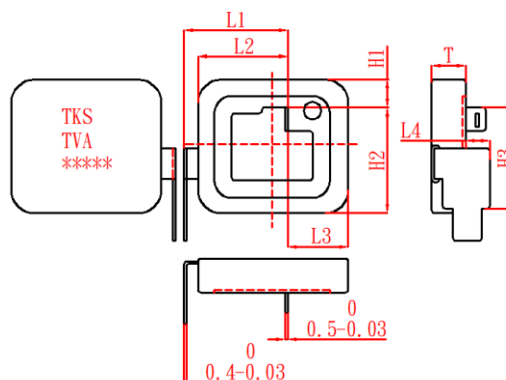

#### ● KQMV Type

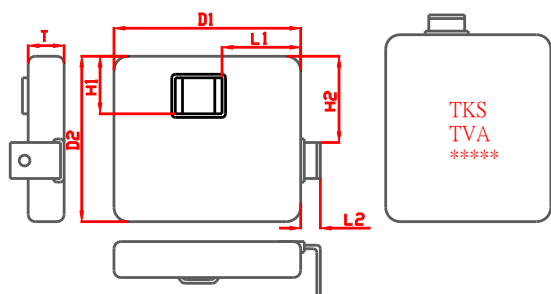

#### ● KQMH Type

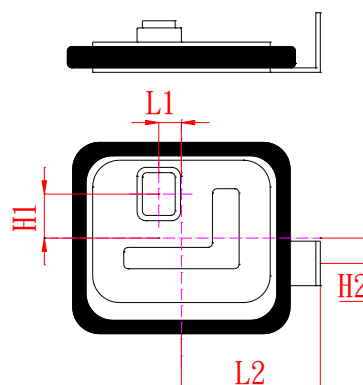

(Unit: mm)

Structure	L1	L2	L3	L4	H1.	H2	H3	D1max	D2max	Tmax
KQAP	2.9±0.5	20.7±0.5	4±0.5	---	10.1±0.5	11.2±0.5	4.6±0.5	26.2	23.2	8
KQBJ	18±0.3	15.75+0.3~0.7	10.25+0.3~0.7	3±0.5	5.05+0.1~0.5	17.75+0.4~0.7	17.35±0.3	---	---	7.6
KQMV	11±0.5	2.8±0.5	---	---	8±0.5	12±0.5	---	26.5	23.5	6.8
KQMH	2.55±0.5	15.65±0.5	---	---	4.95±0.5	2.85±0.5	---	---	---	---

# Varistor: TVA22 Series



## Strap Type Varistor for Over-Voltage Protection

### ■ Electrical Characteristics

Part No.	Varistor Voltage (@ 1mA DC)	Max. Continuous Voltage		Max. Clamping Voltage (8/20μs)		Max. Surge Current (8/20μs)	Surge Operating Duty Test (8/20μs)		Max. Energy (2ms)	Rated Power	Safety Approvals
	V <sub>1mA</sub> (V)	V <sub>AC(rms)</sub> (V)	V <sub>DC</sub> (V)	V <sub>P</sub> (V)	I <sub>P</sub> (A)	I <sub>max</sub> (KA)	I <sub>max</sub> (KA)	I <sub>n</sub> (KA)	W <sub>max</sub> (J)	P (W)	UL 1449 & cUL
TVA22820K□□□□	82	50	65	135	175	25	20	10	70	1.0	√
TVA22101K□□□□	100	60	85	165	175	25	20	10	87	1.0	√
TVA22121K□□□□	120	75	100	200	175	25	20	10	104	1.0	√
TVA22151K□□□□	150	95	125	250	175	25	20	10	132	1.0	√
TVA22181K□□□□	180	115	150	300	175	25	20	10	120	1.0	√
TVA22201K□□□□	200	130	170	340	175	25	20	10	128	1.0	√
TVA22221K□□□□	220	140	180	360	175	25	20	10	135	1.0	√
TVA22241K□□□□	240	150	200	395	175	25	20	10	146	1.0	√
TVA22271K□□□□	270	175	225	455	175	25	20	10	170	1.0	√
TVA22361K□□□□	360	230	300	595	175	25	20	10	190	1.0	√
TVA22391K□□□□	390	250	320	650	175	25	20	10	210	1.0	√
TVA22431K□□□□	430	275	350	710	175	25	20	10	220	1.0	√
TVA22471K□□□□	470	300	385	775	175	25	20	10	225	1.0	√
TVA22511K□□□□	510	320	415	845	175	25	20	10	230	1.0	√
TVA22561K□□□□	560	350	450	930	175	25	20	10	235	1.0	√
TVA22621K□□□□	620	385	505	1025	175	25	20	10	240	1.0	√
TVA22681K□□□□	680	420	560	1120	175	25	20	10	250	1.0	√
TVA22751K□□□□	750	460	615	1240	175	25	20	10	275	1.0	√
TVA22781K□□□□	780	485	640	1290	175	25	20	10	290	1.0	√
TVA22821K□□□□	820	510	670	1355	175	25	20	10	300	1.0	√
TVA22911K□□□□	910	550	745	1500	175	25	20	10	340	1.0	√
TVA22951K□□□□	950	575	765	1570	175	25	20	10	355	1.0	√
TVA22102K□□□□	1000	625	825	1650	175	25	20	10	375	1.0	√
TVA22112K□□□□	1100	680	895	1815	175	25	20	10	390	1.0	√
TVA22122K□□□□	1200	750	980	2000	175	25	20	10	420	1.0	√

Note: □□□□ is structure code and please refer to “Structures and Dimensions.”

# Varistor: TVA22 Series

## Strap Type Varistor for Over-Voltage Protection



### ■ Power Derating Curve

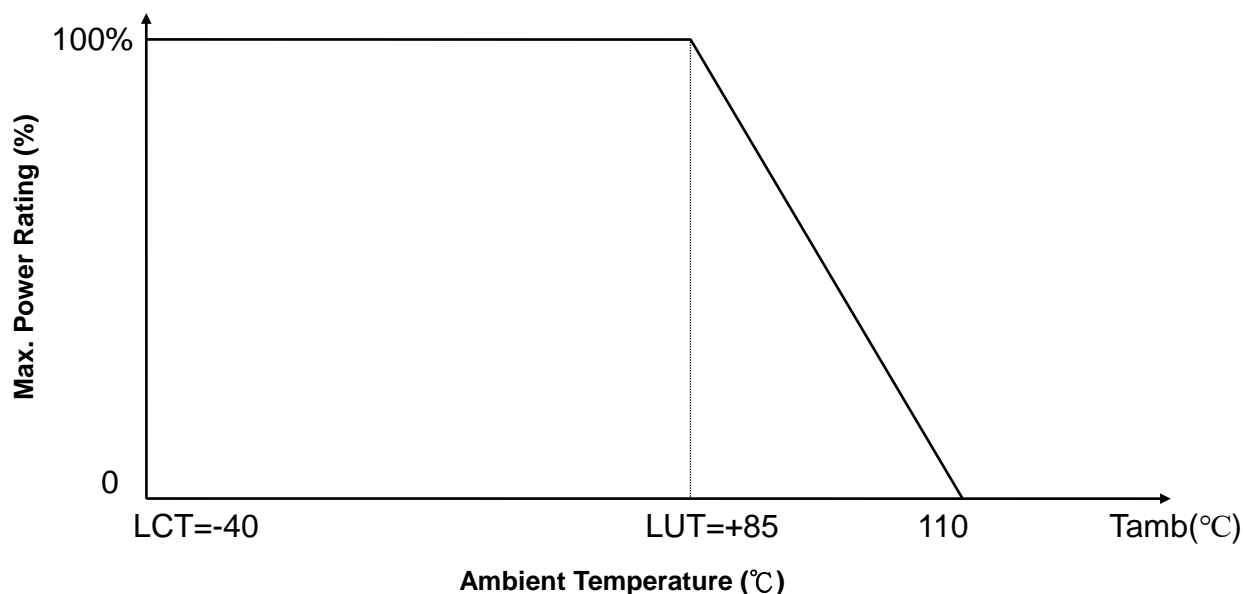

### ■ Max. Leakage Current and Max. Clamping Voltage Curves

**Max. Leakage Current and Max. Clamping Voltage Curves (TVA22820 – TVT22122)**

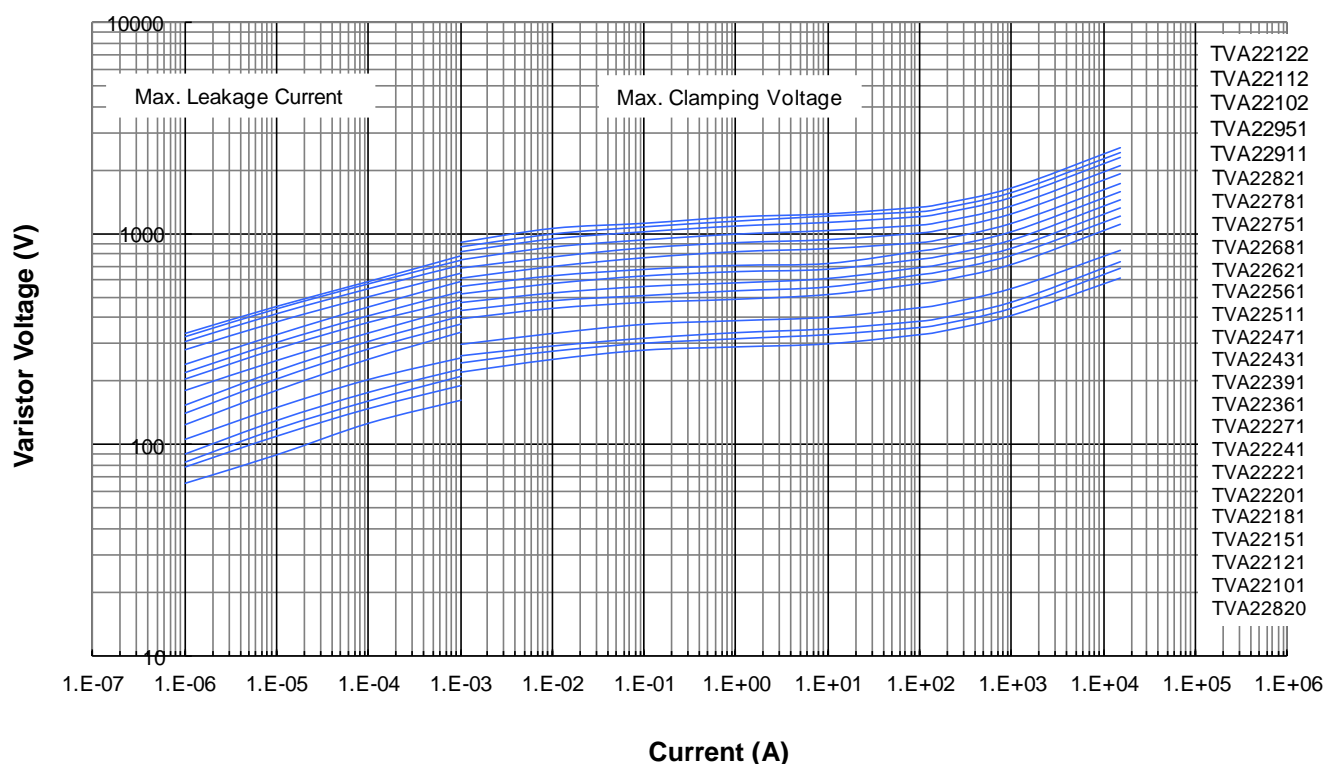

# Varistor: TVA22 Series

## Strap Type Varistor for Over-Voltage Protection



### ■ Surge Life Time Ratings

Surge Life Times Ratings (TVA22820 – TVT22122)

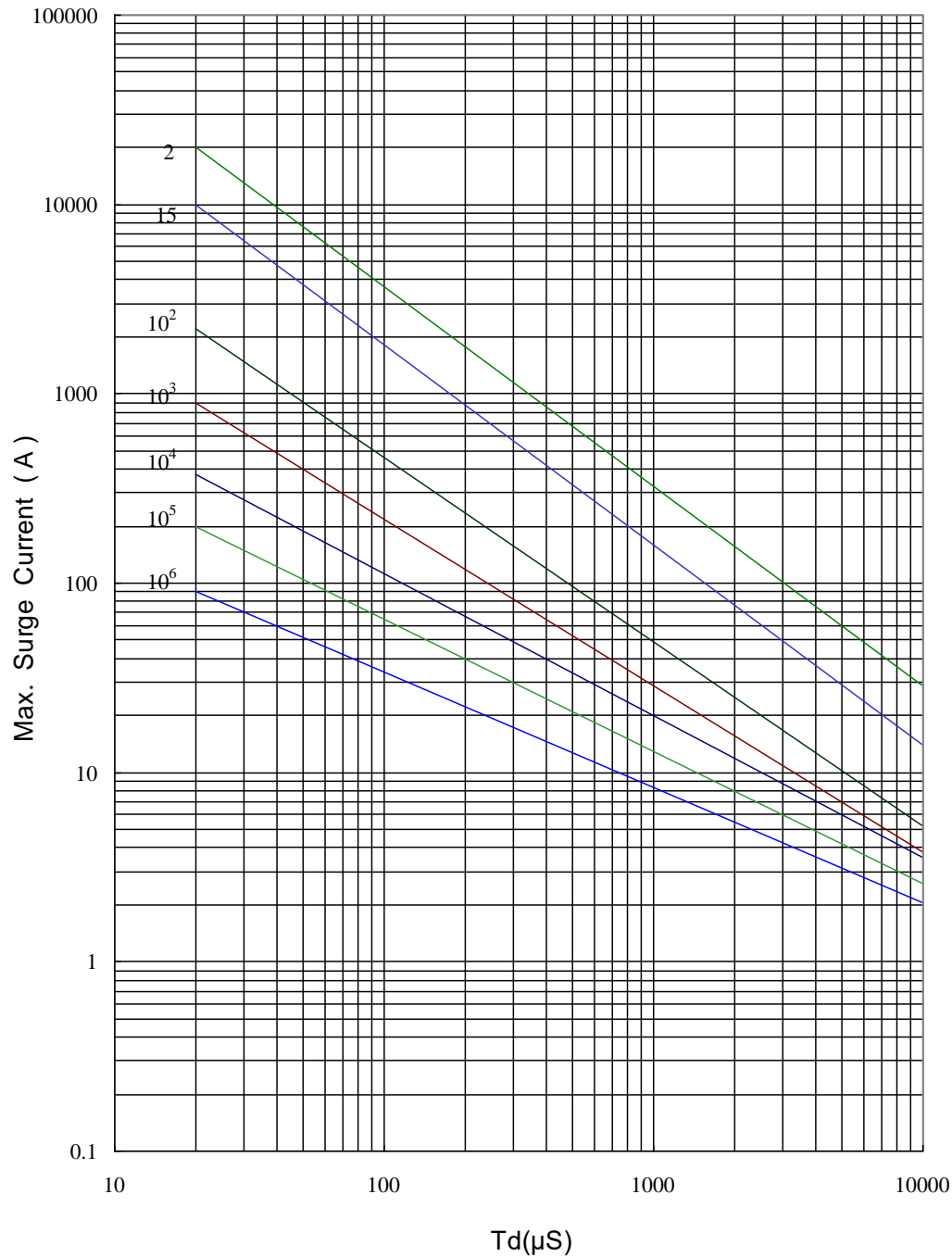

# Varistor: TVA22 Series

## Strap Type Varistor for Over-Voltage Protection



### ■ Reliability

Item	Standard	Test conditions / Methods	Specifications															
Tensile Strength of Terminals	IEC 60068-2-21	<p>Gradually apply the specified force and keep the unit fixed for 10±1 sec.</p> <table border="1"> <thead> <tr> <th>Terminal cross-sectional area (mm<sup>2</sup>)</th> <th>Terminal diameter (mm)</th> <th>Force (Kg)</th> </tr> </thead> <tbody> <tr> <td>0.5&lt;S≤1.2</td> <td>0.8&lt;d≤1.25</td> <td>2.0</td> </tr> <tr> <td>1.2&lt;S</td> <td>1.25&lt;d</td> <td>4.0</td> </tr> </tbody> </table>	Terminal cross-sectional area (mm <sup>2</sup> )	Terminal diameter (mm)	Force (Kg)	0.5<S≤1.2	0.8<d≤1.25	2.0	1.2<S	1.25<d	4.0	$ \Delta V_{1mA} / V_{1mA}  \leq 5\%$ No visible damage						
Terminal cross-sectional area (mm <sup>2</sup> )	Terminal diameter (mm)	Force (Kg)																
0.5<S≤1.2	0.8<d≤1.25	2.0																
1.2<S	1.25<d	4.0																
Vibration (Optional)	IEC 60068-2-6	Frequency range: 10~55Hz Amplitude: 0.75mm or 98m/s <sup>2</sup> Direction: 3 mutually perpendicular directions, 2 hrs each.	$ \Delta V_{1mA} / V_{1mA}  \leq 5\%$ No visible damage															
Solderability	IEC 60068-2-20	245±3°C, 3±0.3 sec (For Lead wire structure)	At least 95% of terminal electrode is covered by new solder															
Resistance to Soldering Heat	IEC 60068-2-20	260±3°C, 10±1 sec	$ \Delta V_{1mA} / V_{1mA}  \leq 5\%$ No visible damage															
High Temperature Storage	IEC 60068-2-2	110±2°C x 1000±24 hrs	$ \Delta V_{1mA} / V_{1mA}  \leq 5\%$ No visible damage															
Damp Heat, Steady State	IEC 60068-2-78	a. 40±2°C, 90 ~ 95 % RH, 1344 hrs b. 40±2°C, 90 ~ 95 % RH, at 10%Vdc, 1344 hrs	$ \Delta V_{1mA} / V_{1mA}  \leq 5\%$ No visible damage Insulation Resistance ≥100MΩ															
Rapid Change of Temperature (optional)	IEC 60068-2-14	The conditions shown below shall be repeated 5 cycles <table border="1"> <thead> <tr> <th>Step</th> <th>Temperature (°C)</th> <th>Period (minutes)</th> </tr> </thead> <tbody> <tr> <td>1</td> <td>-40±3</td> <td>30±3</td> </tr> <tr> <td>2</td> <td>Room temperature</td> <td>≤3</td> </tr> <tr> <td>3</td> <td>85±2</td> <td>30±3</td> </tr> <tr> <td>4</td> <td>Room temperature</td> <td>≤3</td> </tr> </tbody> </table>	Step	Temperature (°C)	Period (minutes)	1	-40±3	30±3	2	Room temperature	≤3	3	85±2	30±3	4	Room temperature	≤3	$ \Delta V_{1mA} / V_{1mA}  \leq 5\%$ No visible damage
Step	Temperature (°C)	Period (minutes)																
1	-40±3	30±3																
2	Room temperature	≤3																
3	85±2	30±3																
4	Room temperature	≤3																
High Temp. Load	MIL-STD-202 Method 108	85±2°C, 1000±24 hrs at V <sub>DC</sub> or V <sub>rms</sub> (Max. Continuous Voltage)	$ \Delta V_{1mA} / V_{1mA}  \leq 10\%$ No visible damage															
8/20μs Surge Operating Duty Test	IEC 61643-11	a. Measured limiting voltage @ 0.1In, 0.2In, 0.5In, 1.0In, I <sub>max</sub> b. Operating duty test: In*15 times	$ \Delta V_{1mA} / V_{1mA}  \leq 10\%$ No visible damage															
Climatic Sequence	IEC 61051-1	a. Dry heat at 85°C, 16hrs b. Damp heat, 1st cycle: 55°C, 95RH, 24hrs (IEC60068-2-30) c. Cold, -40°C, 2 hrs d. Damp heat, additional 5 cycles, 120 hrs	$ \Delta V_{1mA} / V_{1mA}  \leq 10\%$ No visible damage Insulation Resistance ≥100MΩ															
Voltage Proof	IEC 61051-1	Metal balls method, 2500 V <sub>ac</sub> 1 min	No visible damage															

# Varistor: TVA22 Series

## Strap Type Varistor for Over-Voltage Protection



### ■ Packaging

#### ● Bulk Packing

Product Series	Quantity (pcs/bag)
TVA22*KQAP	112
TVA22*KQBJ	
TVA22*KQMV	
TVA22*KQMH	

### ■ Warehouse Storage Conditions of Products

- Storage Conditions :
  1. Storage Temperature:  $-10^{\circ}\text{C}\sim+40^{\circ}\text{C}$
  2. Relative Humidity:  $\leq 75\%RH$
  3. Keep away from corrosive atmosphere and sunlight.
- Period of Storage : 1 year