

SMD Type 1500 W

■ Features

1. Glass passivated chip
2. 1500W peak pulse power capability at 10/1000 μ s waveform, repetition rate (duty cycle): 0.01%
3. Excellent clamping capability
4. Very fast response time
5. Low clamping voltage
6. Low leakage current
7. Meets MSL level 1, per J-STD-020, LF maximum peak of 260°C
8. JESD22-A114-B ESD Voltage: HBM 15KV
9. JEDEC EIA/JESD22-C101F ESD Voltage: CDM 500V
10. JEDEC EIA/JESD22-A115 ESD Voltage: MM 400V
11. ESD-immunity acc. IEC 61000-4-2 \pm 30kV(contact), \pm 30kV(air)
12. Halogen free and RoHS compliant

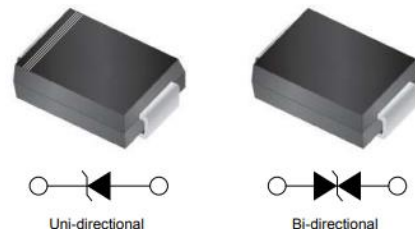

■ Recommended Applications

1. Computers
2. Telecom system
3. Industrial equipment
4. Consumer electronic applications
5. Other VCC bus and I/O interfaces

■ Mechanical Data

1. Case: Molded plastic, SMB/ DO-214AA
2. Epoxy: UL 94V-0 rate flame retardant
3. Terminals: Solderable per MIL-STD-750, method 2026
4. Polarity: Color band denotes cathode end
5. Mounting Position: Any

■ Part Number Code

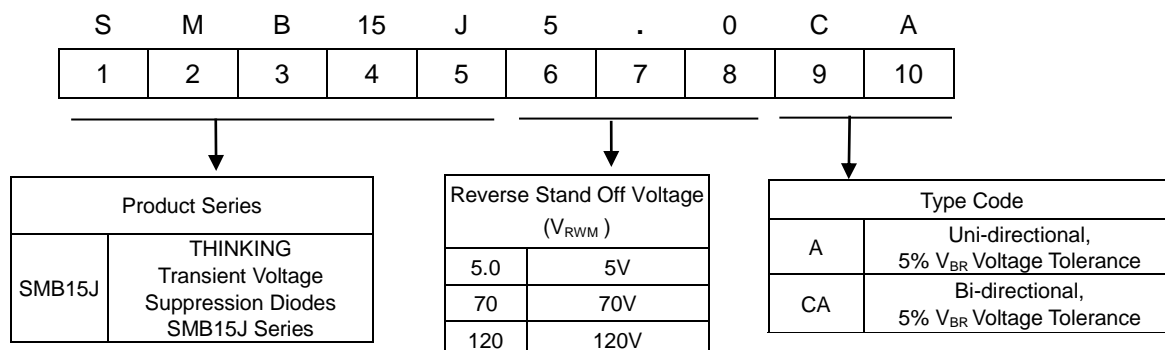

SMD Type 1500 W

Structures and Dimensions

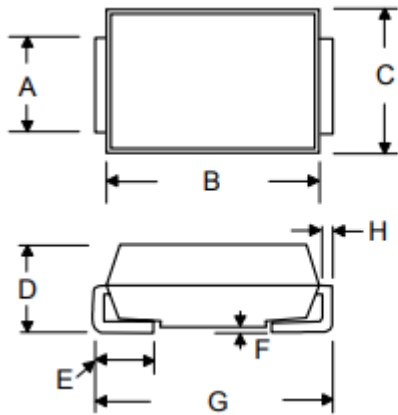

Symbol	Dimensions in millimeters	
	Min	Max
A	1.80	2.20
B	4.06	4.75
C	3.30	3.94
D	1.99	2.61
E	0.76	1.52
F	-	0.20
G	5.08	5.59
H	0.15	0.31

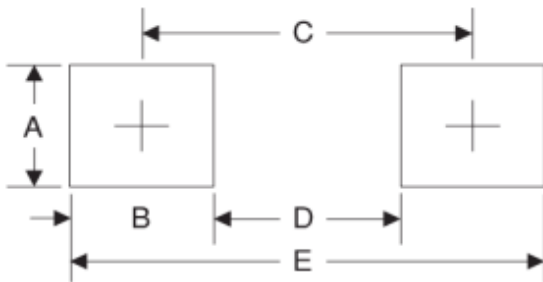

Symbol	Unit (mm)	Unit (inch)
A	2.30	0.091
B	2.00	0.078
C	4.10	0.161
D	2.10	0.083
E	6.10	0.240

Maximum Rating (TA=25°C unless otherwise noted)

Parameter	Symbol	Value	Unit
Peak power dissipation with a 10/1000μs waveform (Note 1,2)	P _{PPM}	1500	W
Peak pulse current with 10/1000 μs waveform (Note 1)	I _{PPM}	See next table	A
Peak forward surge current, 8.3 ms single half sine-wave (Note 3)	I _{FSM}	200	A
Power dissipation on infinite heatsink at T _L =75°C	P _D	6.5	W
Typical thermal resistance junction to ambient	R _{θJA}	75	°C/W
Typical thermal resistance junction to lead	R _{θJL}	15	°C/W
Operating junction and storage temperature range	T _J , T _{STG}	-55 to +150	°C

Note:

1. Non-repetitive current pulse, per Fig. 3 and derated above T_A=25°C per Fig. 2.
2. Mounted on 5.0 x 5.0mm copper pad to each terminal.
3. Measured on 8.3ms single half sine wave or equivalent square wave for unidirectional device only, duty cycle=4 per minute maximum.

TVS Diode: SMB15J Series



SMD Type 1500 W

■ Electrical Characteristics (T_A=25°C unless otherwise noted)

Part No. (Uni)	Part No. (Bi)	Reverse Stand off Voltage V _{RWM} (V)	Breakage Voltage V _{BR} @ I _T		Test Current I _T (mA)	Maximum Clamping Voltage V _C @ I _{pp} (V)	Maximum Peak Pulse Current I _{pp} (A)	Maximum Reverse Leakage I _R @ V _{RWM} (μA)	Marking Code	
			Min (V)	Max (V)					Uni	Bi
SMB15J5.0A	SMB15J5.0CA	5	6.4	7	10	9.2	163.04	800	GDE	BDE
SMB15J6.0A	SMB15J6.0CA	6	6.7	7.37	10	10.3	145.63	800	GDG	BDG
SMB15J6.5A	SMB15J6.5CA	6.5	7.2	7.98	10	11.2	133.93	500	GDK	BDK
SMB15J7.0A	SMB15J7.0CA	7	7.8	8.6	10	12	125	200	GDM	BDM
SMB15J7.5A	SMB15J7.5CA	7.5	8.3	9.21	1	12.9	116.28	100	GDP	BDP
SMB15J8.0A	SMB15J8.0CA	8	8.9	9.83	1	13.6	110.29	50	GDR	BDR
SMB15J8.5A	SMB15J8.5CA	8.5	9.4	10.4	1	14.4	104.17	20	GDT	BDT
SMB15J9.0A	SMB15J9.0CA	9	10	11.1	1	15.4	97.4	10	GDV	BDV
SMB15J10A	SMB15J10CA	10	11.1	12.3	1	17	88.24	5	GDX	BDX
SMB15J11A	SMB15J11CA	11	12.2	13.5	1	18.2	82.42	1	GDZ	BDZ
SMB15J12A	SMB15J12CA	12	13.3	14.7	1	19.9	75.38	1	GEE	BEE
SMB15J13A	SMB15J13CA	13	14.4	15.9	1	21.5	69.77	1	GEG	BEG
SMB15J14A	SMB15J14CA	14	15.6	17.2	1	23.2	64.66	1	GEK	BEK
SMB15J15A	SMB15J15CA	15	16.7	18.5	1	24.4	61.48	1	GEM	BEM
SMB15J16A	SMB15J16CA	16	17.8	19.7	1	26	57.69	1	GEP	BEP
SMB15J17A	SMB15J17CA	17	18.9	20.9	1	27.6	54.35	1	GER	BER
SMB15J18A	SMB15J18CA	18	20	22.1	1	29.2	51.37	1	GET	BET
SMB15J19A	SMB15J19CA	19	21.1	23.3	1	30.8	48.73	1	GEW	BEW
SMB15J20A	SMB15J20CA	20	22.2	24.5	1	32.4	46.3	1	GEV	BEV
SMB15J22A	SMB15J22CA	22	24.4	26.9	1	35.5	42.25	1	GEX	BEX
SMB15J24A	SMB15J24CA	24	26.7	29.5	1	38.9	38.56	1	GEZ	BEZ
SMB15J26A	SMB15J26CA	26	28.9	31.9	1	42.1	35.63	1	GFE	BFE
SMB15J28A	SMB15J28CA	28	31.1	34.4	1	45.4	33.04	1	GFG	BFG
SMB15J30A	SMB15J30CA	30	33.3	36.8	1	48.4	30.99	1	GFK	BFK
SMB15J33A	SMB15J33CA	33	36.7	40.6	1	53.3	28.14	1	GFM	BFM
SMB15J36A	SMB15J36CA	36	40	44.2	1	58.1	25.82	1	GFP	BFP
SMB15J40A	SMB15J40CA	40	44.4	49.1	1	64.5	23.26	1	GFR	BFR
SMB15J43A	SMB15J43CA	43	47.8	52.8	1	69.4	21.61	1	GFT	BFT
SMB15J45A	SMB15J45CA	45	50	55.3	1	72.7	20.63	1	GFV	BFV
SMB15J48A	SMB15J48CA	48	53.3	58.9	1	77.4	19.38	1	GFX	BFX

TVS Diode: SMB15J Series



SMD Type 1500 W

■ Electrical Characteristics (T_A=25°C unless otherwise noted)

Part No. (Uni)	Part No. (Bi)	Reverse Stand off Voltage V _{RWM} (V)	Breakage Voltage V _{BR} @ I _T		Test Current I _T (mA)	Maximum Clamping Voltage V _C @ I _{pp} V _C (V)	Maximum Peak Pulse Current I _{pp} (A)	Maximum Reverse Leakage I _R @V _{RWM} I _R (μA)	Marking Code	
			Min(V)	Max(V)					Uni	Bi
SMB15J51A	SMB15J51CA	51	56.7	62.7	1	82.4	18.2	1	GFZ	BFZ
SMB15J54A	SMB15J54CA	54	60	66.3	1	87.1	17.22	1	GGE	BGE
SMB15J58A	SMB15J58CA	58	64.4	71.2	1	93.6	16.03	1	GGG	BGG
SMB15J60A	SMB15J60CA	60	66.7	73.7	1	96.8	15.5	1	GGK	BGK
SMB15J64A	SMB15J64CA	64	71.1	78.6	1	103	14.56	1	GGM	BGM
SMB15J70A	SMB15J70CA	70	77.8	86	1	113	13.27	1	GGP	BGP
SMB15J75A	SMB15J75CA	75	83.3	92.1	1	121	12.4	1	GGR	BGR
SMB15J78A	SMB15J78CA	78	86.7	95.8	1	126	11.9	1	GGT	BGT
SMB15J80A	SMB15J80CA	80	88.8	97.6	1	129.6	11.57	1	GGW	BGW
SMB15J85A	SMB15J85CA	85	94.4	104	1	137	10.95	1	GGV	BGV
SMB15J90A	SMB15J90CA	90	100	111	1	146	10.27	1	GGX	BGX
SMB15J100A	SMB15J100CA	100	111	123	1	162	9.26	1	GGZ	BGZ
SMB15J110A	SMB15J110CA	110	122	135	1	177	8.47	1	GHE	BHE
SMB15J120A	SMB15J120CA	120	133	147	1	193	7.77	1	GHG	BHG
SMB15J130A	SMB15J130CA	130	144	159	1	209	7.18	1	GHK	BHK
SMB15J140A	SMB15J140CA	140	155	171	1	226.8	6.61	1	GHL	BHL
SMB15J150A	SMB15J150CA	150	167	185	1	243	6.17	1	GHM	BHM
SMB15J160A	SMB15J160CA	160	178	197	1	259	5.79	1	GHP	BHP
SMB15J170A	SMB15J170CA	170	189	209	1	275	5.45	1	GHR	BHR
SMB15J180A	SMB15J180CA	180	200	220	1	291.6	5.14	1	GHT	BHT
SMB15J190A	SMB15J190CA	190	211	232	1	307.8	4.87	1	GHW	BHW
SMB15J200A	SMB15J200CA	200	224	247	1	324	4.6	1	GHV	BHV

SMD Type 1500 W

■ Typical Characteristics ($T_A=25^\circ\text{C}$ unless otherwise noted)

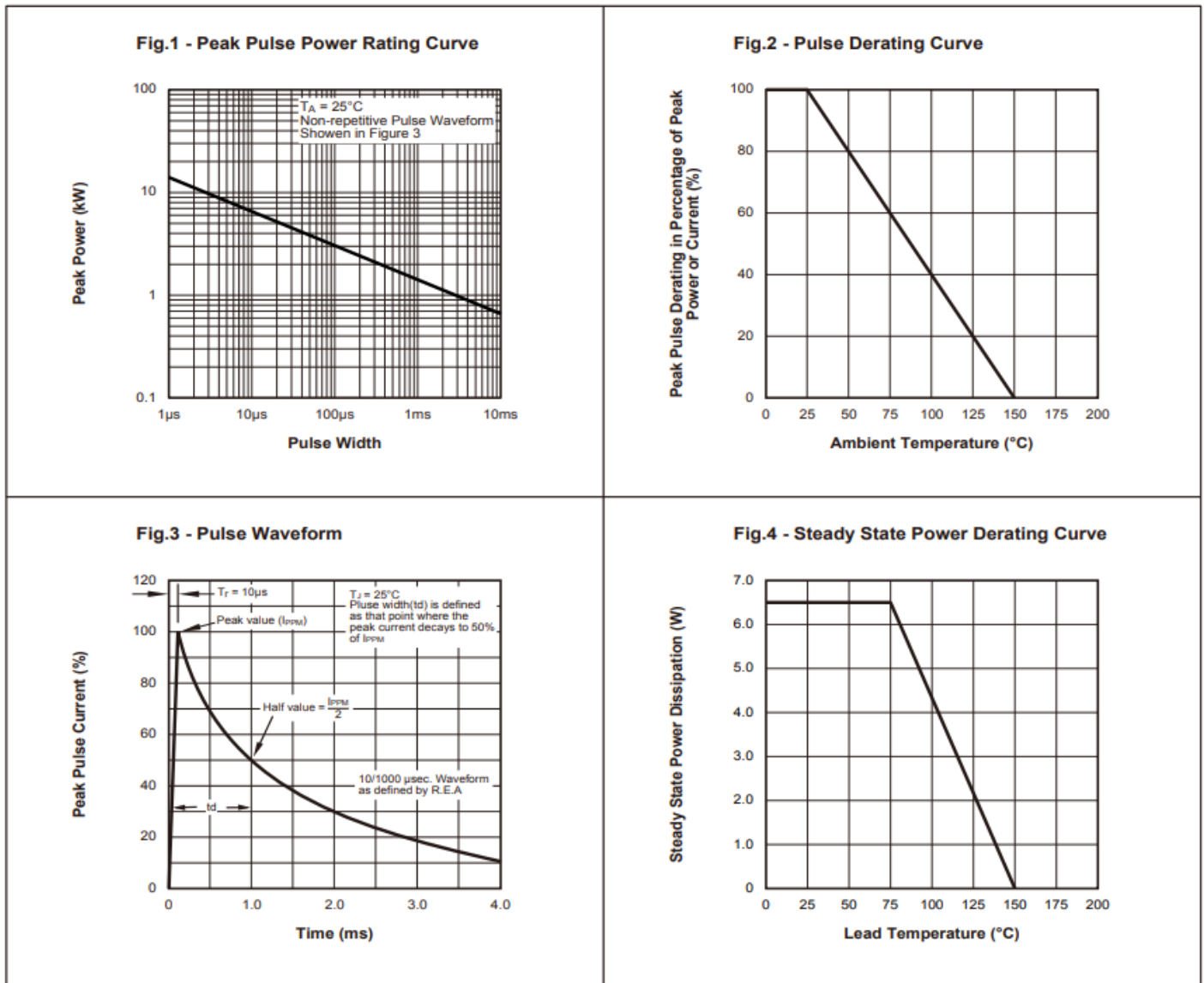

SMD Type 1500 W

■ Soldering Recommendation

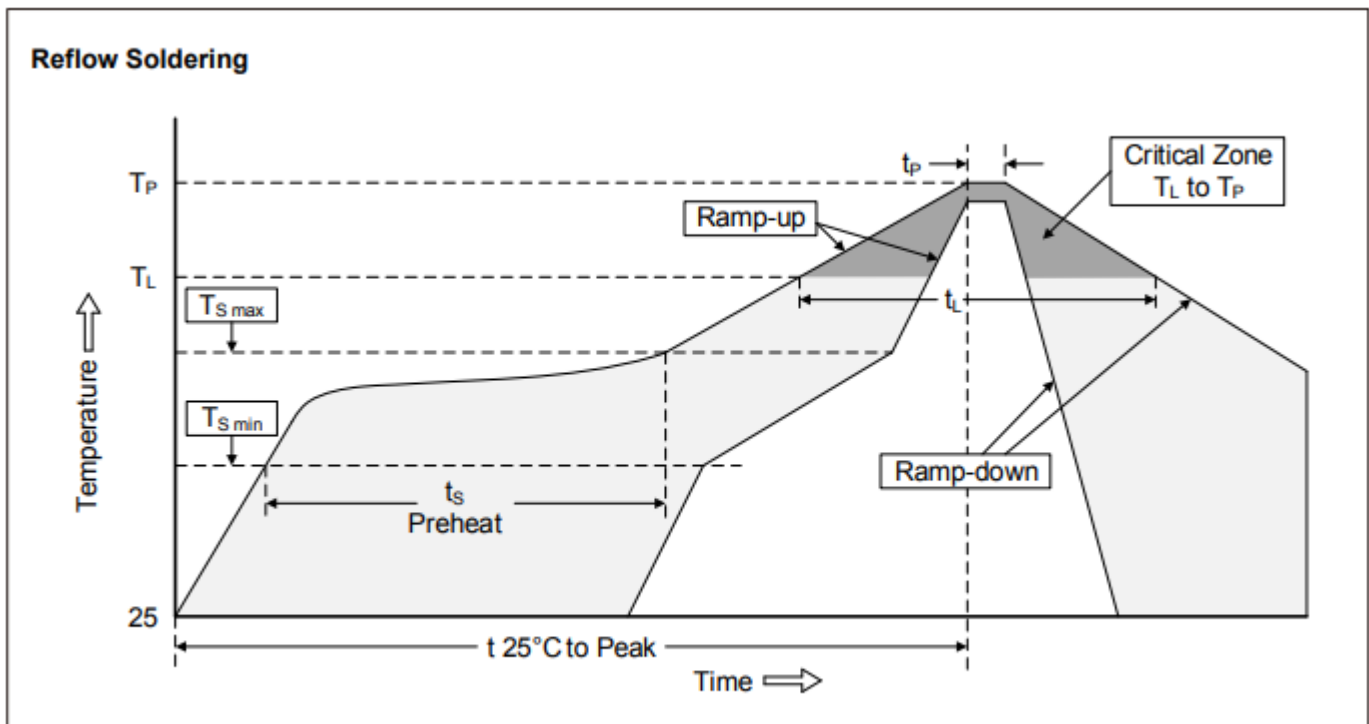

Recommended Conditions

Profile Feature	Pb-Free Assembly
Average ramp-up rate (T_L to T_P)	3°C/second max.
Preheat -Temperature Min ($T_{S\ min}$) -Temperature Max ($T_{S\ max}$) -Time (min to max) (t_s)	150°C 200°C 60-180 seconds
$T_{S\ max}$ to T_L -Ramp-up Rate	3°C/second max.
Time maintained above: -Temperature (T_L) -Time (t_L)	217°C 60-150 seconds
Peak Temperature (T_P)	260°C
Time within 5°C of actual Peak Temperature (t_p)	20-40 seconds
Ramp-down Rate	6°C/second max.
Time 25°C to Peak Temperature	8 minutes max.

SMD Type 1500 W

■ Packaging

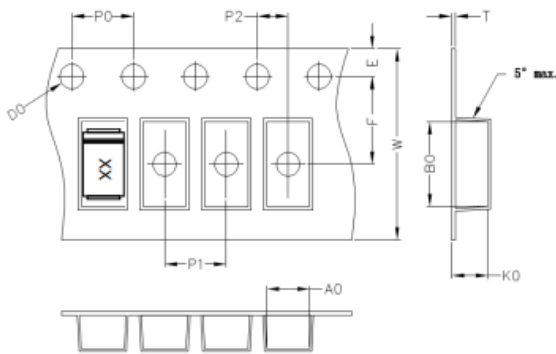

A0	B0	K0	D0	E	F
3.80	5.40	2.45	1.55	1.75	5.50
P0	P1	P2	T	W	Tolerance
4.0	8.0	2.0	0.25	12	0.1

■ Quantity

Series Type	Packaging option	Base quantity	Packaging specification
SMB15J	Tape and reel	3000pcs / reel	EIA STD RS-481

■ Warehouse Storage Conditions of product

- Storage Condition:
 1. Storage Temperature: $-10^{\circ}\text{C} \sim +40^{\circ}\text{C}$
 2. Relative Humidity: $\leq 75\% \text{RH}$
 3. Keep away from corrosive atmosphere and sunlight.
- Period of Storage: 1 year.