

Varistor: TVR-M Series

Dip Type Varistor for Automotive Application (Low Voltage Series)



■ Feature

1. High energy absorption, particularly for load dump
2. Jump-start capable (5 minutes)
3. AEC-Q200 qualified
4. Superior resistance to cyclic temperature stress
5. Operating temperature range: -40°C~+125 °C
6. Agency approval: UL, TUV, CQC

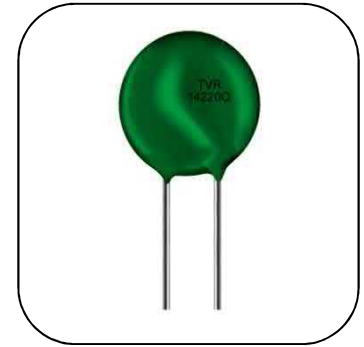

■ Recommended Applications

1. Automotive electronics
2. Low voltage circuit of power supply application
3. Low voltage circuit of industrial application

■ Part Number Code

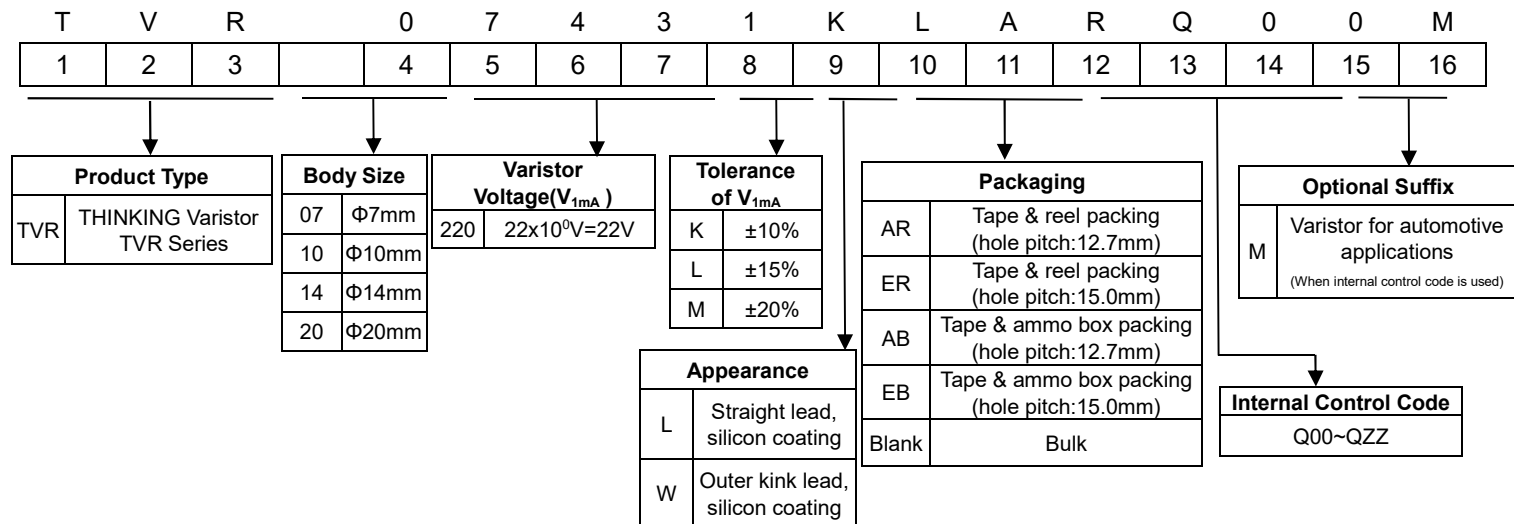

Varistor: TVR-M Series

Dip Type Varistor for Automotive Application (Low Voltage Series)



■ Structure & Dimensions

● L Type (Straight Lead)

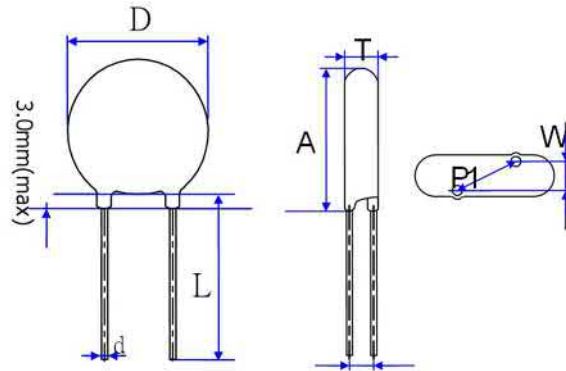

(Unit: mm)

Series	D	Amin.	Lmin	$\Phi d \pm 0.02$	$P1 \pm 1.0$	T & W
TVR07-M	7.5~9.6	11.0	26.5	0.6	5.0	Please refer to Electrical Characteristics Table
TVR10-M	11.0~14.4	15.0	26.5	0.8	7.5	
TVR14-M	14.4~18.0	18.5	26.5	0.8	7.5	
TVR20-M	20.0~24.0	25.5	22.5	1.0	10.0	

● W Type (Outer Kink Lead)

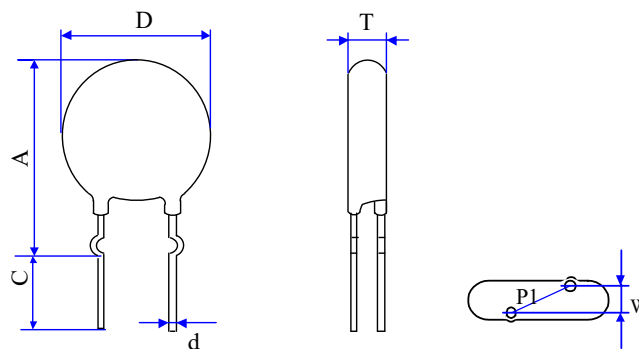

(Unit: mm)

Series	Dmax.	Amax	Cmin	$\Phi d \pm 0.02$	$P1 \pm 1.0$	T & W
TVR10-M	14.4	20.0	20.0	20	0.8	Please refer to Electrical Characteristics Table
TVR14-M	18.0	22.5	22.5	20	0.8	

Note: Size of C is customized, and tolerance of cut lead product is ± 0.5 (Please refer to minimal size in the chart above if customers do not request). Popular minimal size of cut lead products is 3.5 ± 0.5 mm.

Varistor: TVR-M Series

Dip Type Varistor for Automotive Application (Low Voltage Series)



Electrical Characteristics

Low Voltage Series



Part No.	Varistor Voltage (@ 1mA DC)	Max. Continuous Voltage	Max. Clamping Voltage (8/20 μ s)		Max. Surge Current (8/20 μ s)	V _{jump} (5min)	Rated Power	Max. Energy (10/1000 μ s)	Load Dump (ISO7637 Pulse 5a, 10 times)	Dimension		
	V _{1mA}	V _{DC}	V _P	I _P	I _{max}	(V)	P	W _{max}		T _{min}	T _{max}	W \pm 1
	(V)	(V)	(V)	(A)	(A)		(W)	(J)	(J)	(mm)		
12V Power System												
TVR07180	18(14.4~21.6)	14	36	2.5	500	20	0.02	1.1	12	2.3	3.9	1.3
TVR10180	18(14.4~21.6)	14	36	5	1000	20	0.05	2.6	25	2.7	4.3	1.3
TVR14180	18(14.4~21.6)	14	36	10	2000	20	0.1	5.2	50	2.7	4.3	1.3
TVR20180	18(14.4~21.6)	14	36	20	3000	20	0.2	13	100	3.1	4.7	1.3
TVR07220	22(18.7~26.0)	18	43	2.5	500	25	0.02	1.3	12	2.4	4.1	1.4
TVR10220	22(18.7~26.0)	18	43	5	1000	25	0.05	3.2	25	2.8	4.5	1.4
TVR14220	22(18.7~26.0)	18	43	10	2000	25	0.1	6.3	50	2.8	4.5	1.4
TVR20220	22(18.7~26.0)	18	43	20	3000	25	0.2	16	100	3.2	4.9	1.4
TVR07270	27(23.0~31.1)	22	53	2.5	500	30	0.02	1.6	12	2.6	4.3	1.5
TVR10270	27(23.0~31.1)	22	53	5	1000	30	0.05	3.9	25	3.0	4.7	1.5
TVR14270	27(23.0~31.1)	22	53	10	2000	30	0.1	7.8	50	3.0	4.7	1.5
TVR20270	27(23.0~31.1)	22	53	20	3000	30	0.2	19	100	3.4	5.1	1.5
TVR07330	33(30~36)	26	65	2.5	500	36	0.02	2.0	12	2.9	4.5	1.7
TVR10330	33(30~36)	26	65	5	1000	36	0.05	4.8	25	3.3	4.9	1.7
TVR14330	33(30~36)	26	65	10	2000	36	0.1	9.5	50	3.3	4.9	1.7
TVR20330	33(30~36)	26	65	20	3000	36	0.2	24	100	3.7	5.3	1.7
24V Power System												
TVR07390	39(35~43)	31	77	2.5	500	42	0.02	2.4	12	2.9	4.5	1.8
TVR10390	39(35~43)	31	77	5	1000	42	0.05	5.6	25	3.4	5.1	1.8
TVR14390	39(35~43)	31	77	10	2000	42	0.1	11	50	3.4	5.1	1.8
TVR20390	39(35~43)	31	77	20	3000	42	0.2	28	100	3.6	5.3	1.8
TVR07470	47(42~52)	38	93	2.5	500	50	0.02	2.8	12	2.5	5.1	1.9
TVR10470	47(42~52)	38	93	5	1000	50	0.05	6.8	25	2.9	5.5	1.9
TVR14470	47(42~52)	38	93	10	2000	50	0.1	14	50	2.9	5.5	1.9
TVR20470	47(42~52)	38	93	20	3000	50	0.2	34	100	3.9	5.9	1.9
TVR07560	56(50~62)	45	110	2.5	500	59	0.02	3.4	12	2.7	5.55	2.4
TVR10560	56(50~62)	45	110	5	1000	59	0.05	8.1	25	3.1	5.95	2.4
TVR14560	56(50~62)	45	110	10	2000	59	0.1	16	50	3.1	5.95	2.4
TVR20560	56(50~62)	45	110	20	3000	59	0.2	41	100	3.5	6.35	2.4

Varistor: TVR-M Series

Dip Type Varistor for Automotive Application (Low Voltage Series)



Agency Approval

Certified Model No.	Agency	
		
	EN/IEC 61051-1, IEC 61051-2, IEC 61051-2-2	GB/T10193-1997 GB/T10194-1997
	J 50259116 J 50405420	TVR07-M CQC15001128788 CQC15001128790 TVR10-M CQC13001090356 CQC13001090357 TVR14-M CQC15001128796 CQC15001128834 TVR20-M CQC15001128792 CQC15001128793
12V Power Supply		
TVR07180		√
TVR10180		√
TVR14180	√	√
TVR20180	√	√
TVR07220		√
TVR10220		√
TVR14220	√	√
TVR20220	√	√
TVR07270		√
TVR10270		√
TVR14270	√	√
TVR20270	√	√
TVR07330		√
TVR10330		√
TVR14330	√	√
TVR20330	√	√
24V Power Supply		
TVR07390		√
TVR10390		√
TVR14390	√	√
TVR20390	√	√
TVR07470		√
TVR10470		√
TVR14470	√	√
TVR20470	√	√
TVR07560		√
TVR10560		√
TVR14560	√	√
TVR20560	√	√

Varistor: TVR-M Series

Dip Type Varistor for Automotive Application (Low Voltage Series)



■ Power Derating Curve

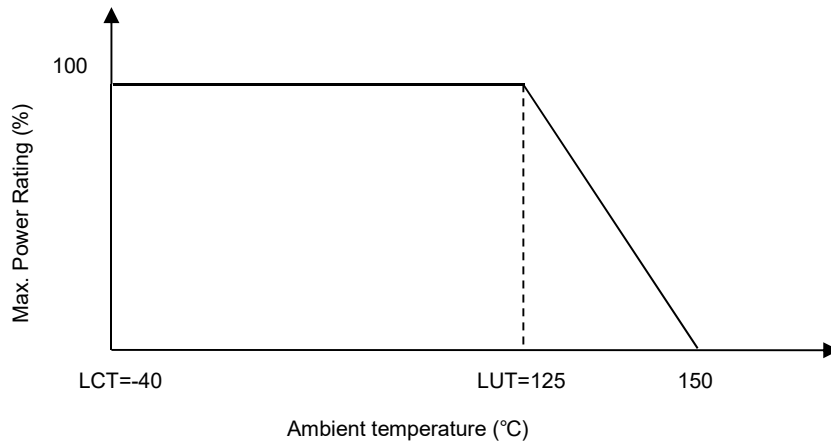

■ Surge Current Standard Waveform

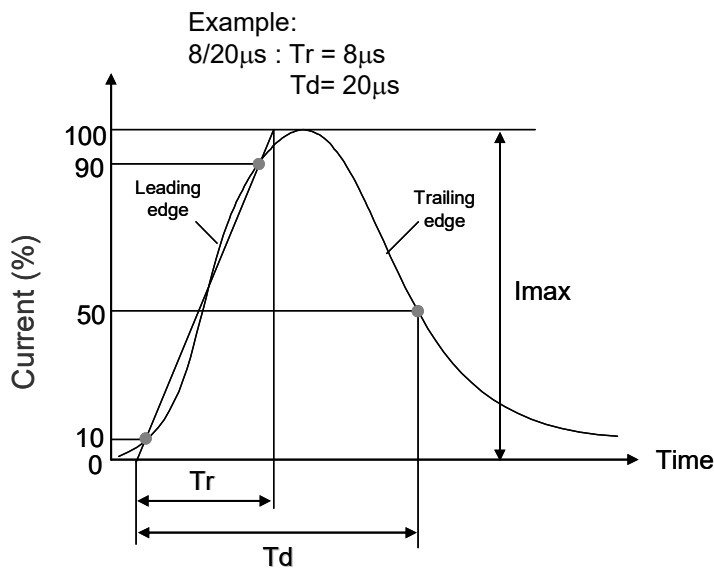

Varistor: TVR-M Series

Dip Type Varistor for Automotive Application (Low Voltage Series)



■ Max. Surge Current Derating Curves

TVR07180M to TVR07560M

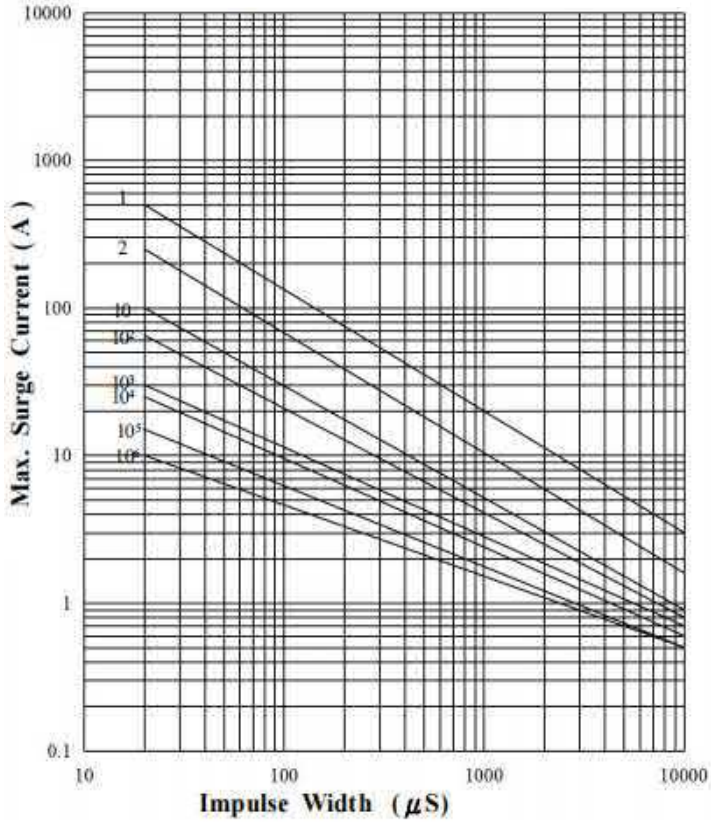

TVR10180M to TVR10560M

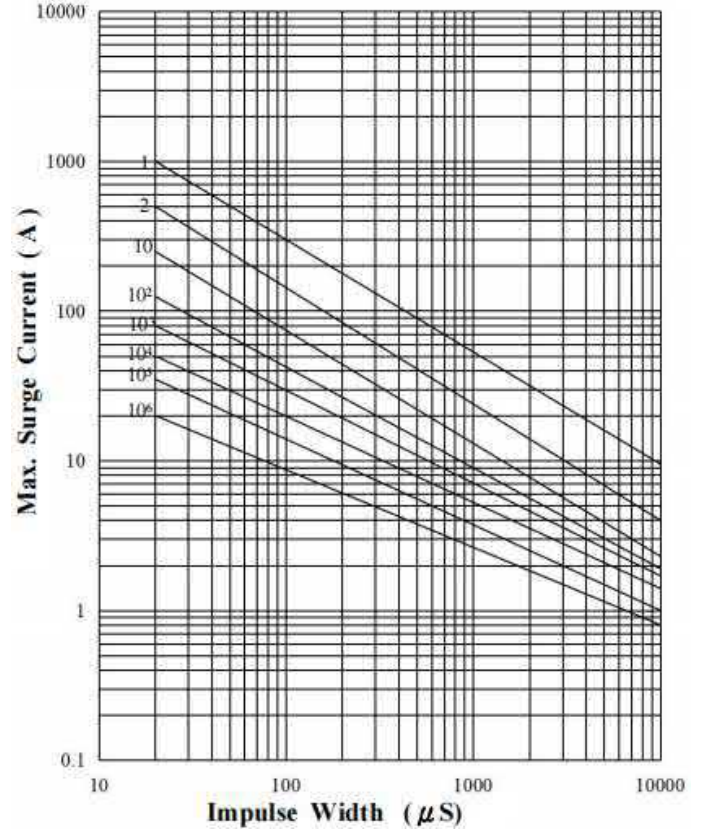

TVR14180M to TVR14560M

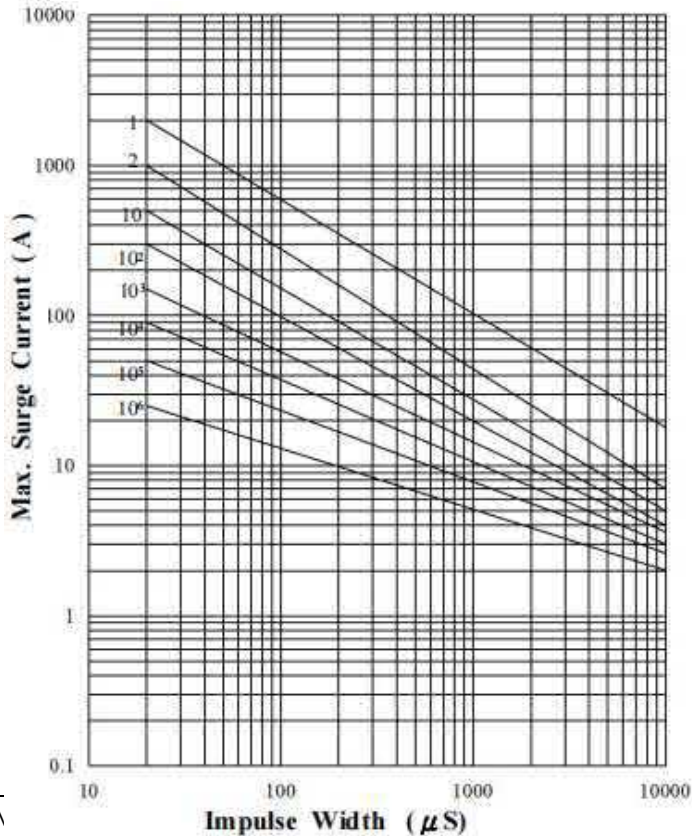

TVR20180M to TVR20560M

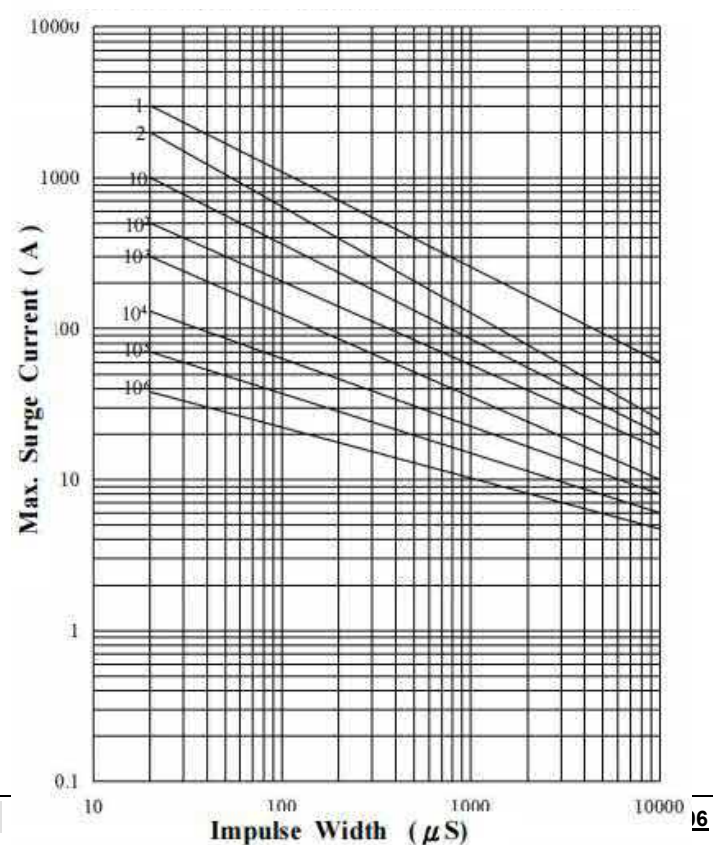

Varistor: TVR-M Series

Dip Type Varistor for Automotive Application (Low Voltage Series)



■ Max. Leakage Current and Max. Clamping Voltage Curves

Max. Leakage Current and Max. Clamping Voltage Curves (TVR07180M to TVR07560M)

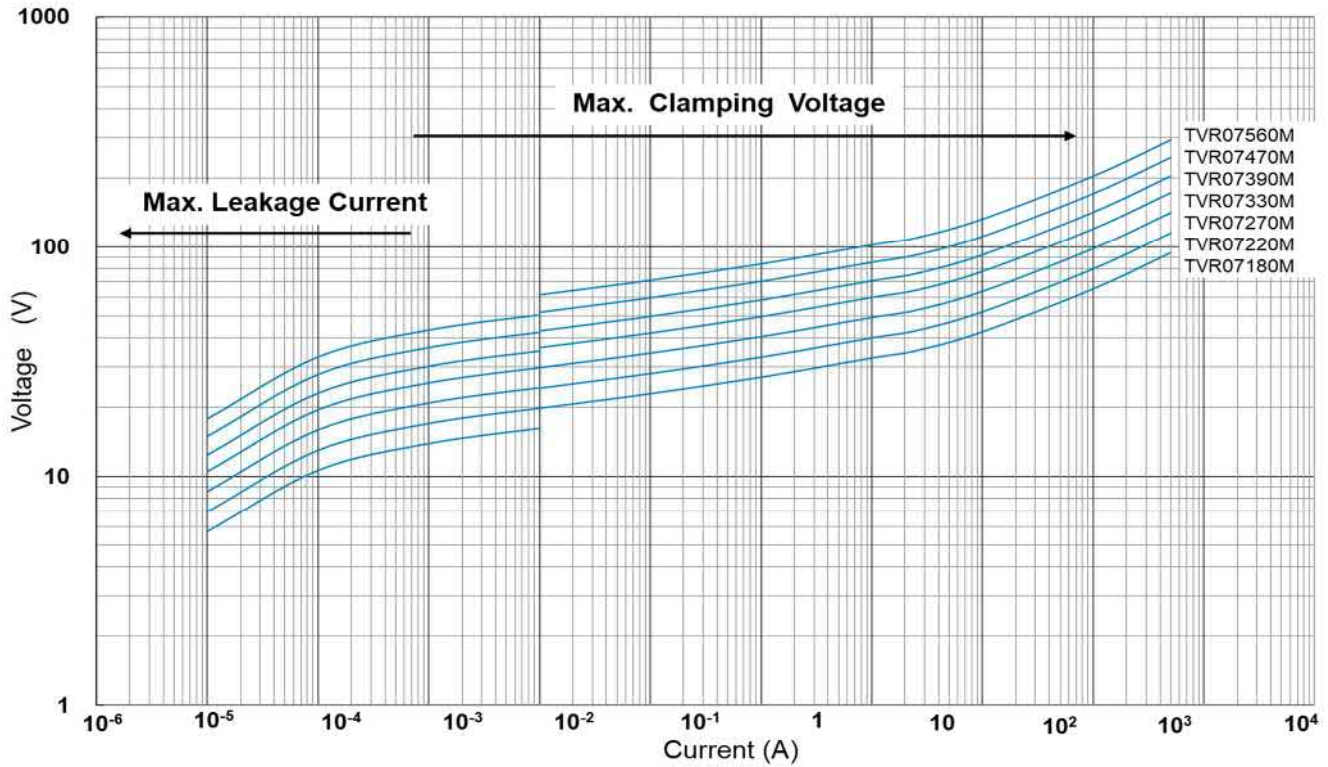

Max. Leakage Current and Max. Clamping Voltage Curves (TVR10180M to TVR10560M)

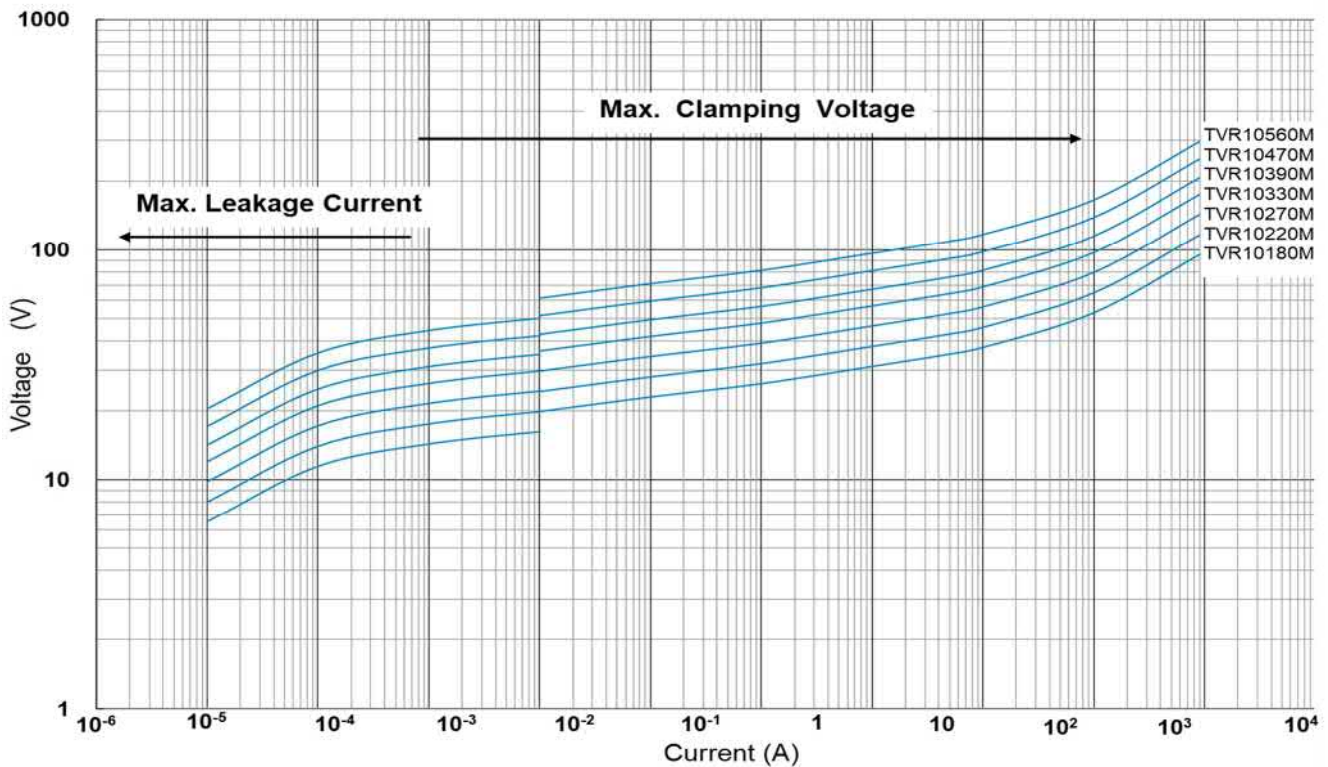

Varistor: TVR-M Series

Dip Type Varistor for Automotive Application (Low Voltage Series)



■ Max. Leakage Current and Max. Clamping Voltage Curves

Max. Leakage Current and Max. Clamping Voltage Curves (TVR14180M to TVR14560M)

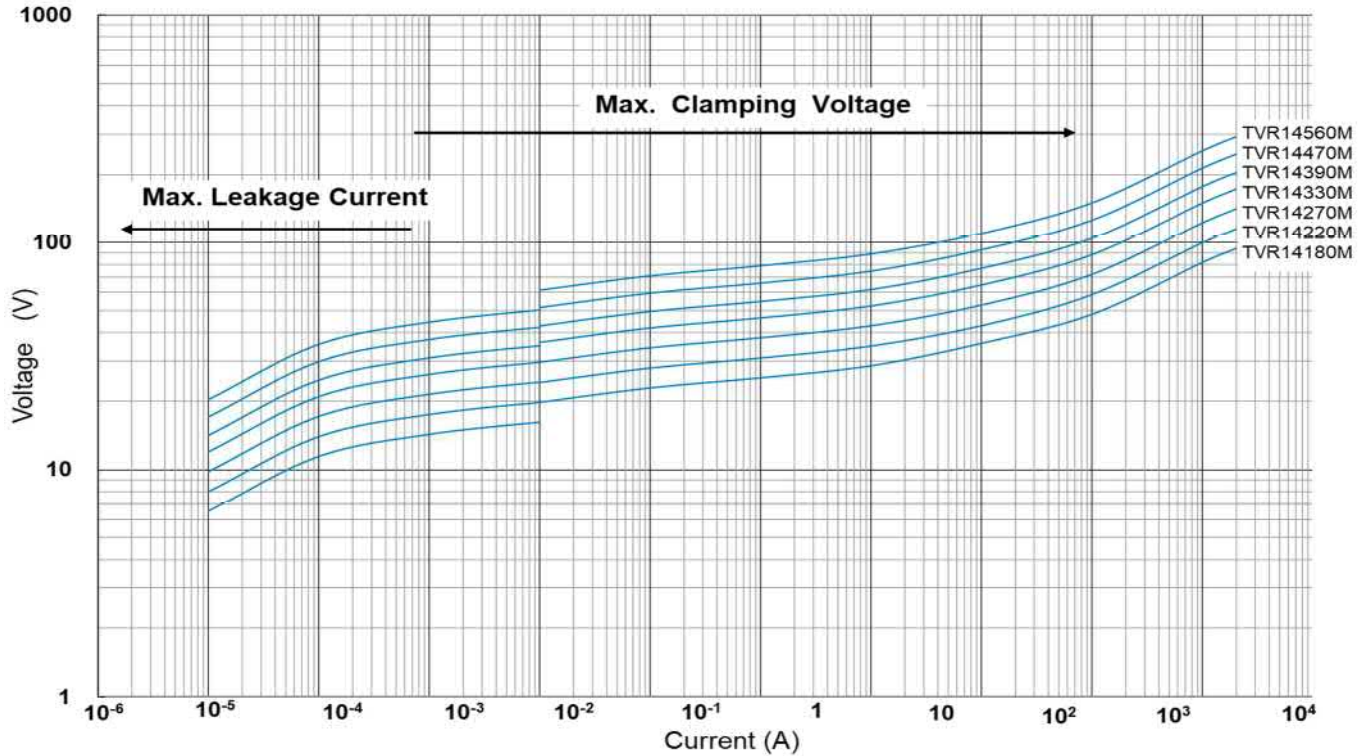

Max. Leakage Current and Max. Clamping Voltage Curves (TVR20180M to TVR20680M)

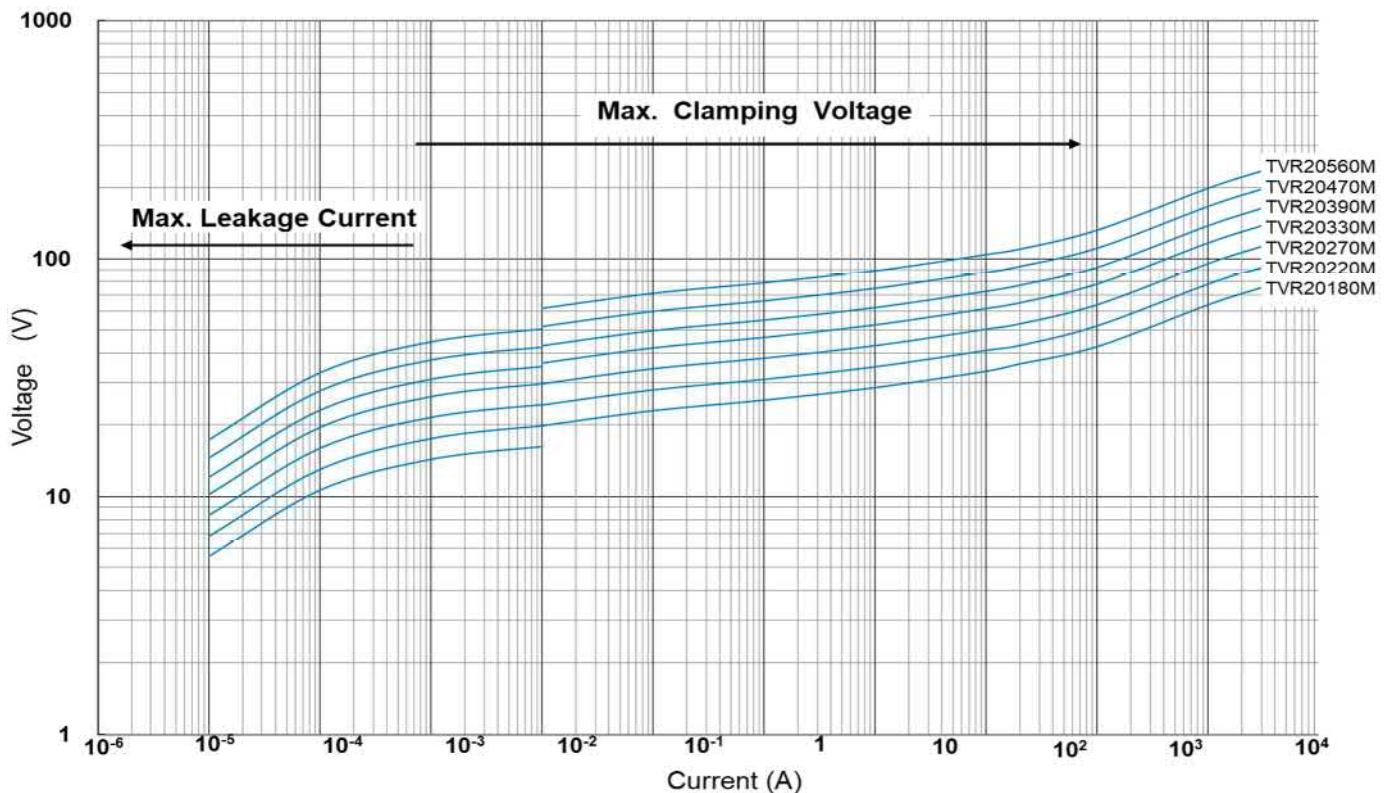

Varistor: TVR-M Series

Dip Type Varistor for Automotive Application (Low Voltage Series)



■ Soldering Recommendation

● IR-reflow Soldering Profile

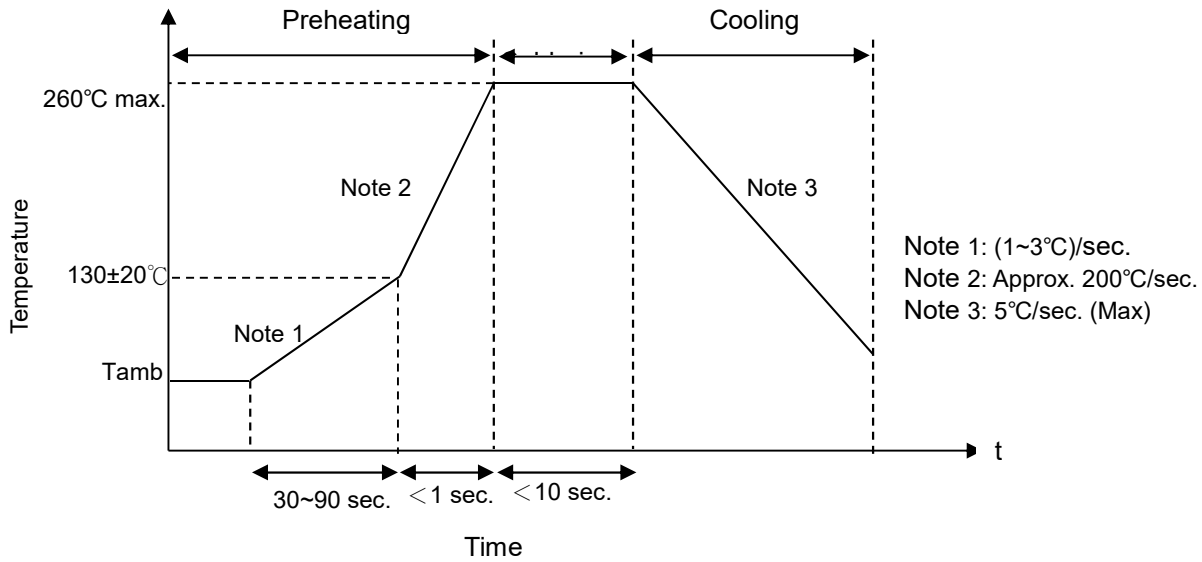

● Recommended Reworking Conditions with Soldering Iron

Item	Conditions
Temperature of Soldering Iron-tip	360°C (max.)
Soldering Time	3 sec (max.)
Diameter of Soldering Iron-tip	Φ3 mm (max.)

Varistor: TVR-M Series

Dip Type Varistor for Automotive Application (Low Voltage Series)



■ Reliability (based on AEC-Q200 Rev-D)

Item	Standard	Test conditions / Methods	Specifications
Varistor voltage	Specification Standard	The voltage between two terminals with the specified measuring current applied is called Vv	To meet the specified value
Clamping voltage	Specification Standard	The maximum voltage between two terminals with the specified standard impulse current (8/20 μ s) applied	To meet the specified value
High Temperature Exposure (Storage)	MIL-STD-202 Method 108	Test temp.: 150 +3/-0°C Duration: 1000 h Unpowered Measurement at 24 \pm 2 hours after test conclusion.	No visible damage $\Delta V_{1mA}/V_{1mA}$ $\leq 10\%$ $\Delta V_{clamp}/V_{clamp}$ $\leq 10\%$
Resistance to Soldering Heat	MIL-STD-202 Method 210	No pre-heat of samples. Temperature 260 \pm 5°C, Time 10 \pm 1 s Immersion and emersion rate 25mm/s \pm 6 mm/s Number of heat cycles 1	No visible damage $\Delta V_{1mA}/V_{1mA}$ $\leq 10\%$ $\Delta V_{clamp}/V_{clamp}$ $\leq 10\%$
Vibration	MIL-STD-202 Method 204	Acceleration 5 g's Sweep time: 20 min Frequency range: 10 to 2000 Hz 3 \times 12 cycles	No visible damage $\Delta V_{1mA}/V_{1mA}$ $\leq 10\%$ $\Delta V_{clamp}/V_{clamp}$ $\leq 10\%$
Solderability	J-STD-002	Steam aging 8hr@93 \pm 3°C, 245 \pm 5°C, 5 +0/-0.5sec	At least 95% of terminal electrode is covered by new solder
Terminal Strength	MIL-STD-202 Method 211	1. Pull test (2.27 kg) 2. Wire-lead bend test (227 g) Duration of the applied forces: 10 \pm 1sec	No visible damage $\Delta V_{1mA}/V_{1mA}$ $\leq 10\%$ $\Delta V_{clamp}/V_{clamp}$ $\leq 10\%$
Biased Humidity	MIL-STD-202 Method 103	Test temp.: 125°C Rel. humidity of air: 85% Duration: 1000 h Test Power Bias at 85%(+5%/-0%)of rated varistor voltage=230Vdc Measurement at 24 \pm 2 hours after test conclusion	No visible damage $\Delta V_{1mA}/V_{1mA}$ $\leq 10\%$ $\Delta V_{clamp}/V_{clamp}$ $\leq 10\%$
Operational Life	MIL-STD-202 Method 108	Test temp.: 125 +3/-0°C Duration: 1000 h Test Power: Bias at 85%(+5%/-0%)of rated varistor voltage	No visible damage $\Delta V_{1mA}/V_{1mA}$ $\leq 10\%$ $\Delta V_{clamp}/V_{clamp}$ $\leq 10\%$
Temperature Cycling	JESD22 Method JA-104	Lower test temp. : -40 +0/-10°C Upper test temp. : 125 +15/-0°C Soak time at lower or upper temp. : 15 min Transfer time: 5 mins Cycle time: 2 Cycles/hr Number of cycles: 1000 Measurement at 24 \pm 2 hours after test conclusion.	No visible damage $\Delta V_{1mA}/V_{1mA}$ $\leq 10\%$ $\Delta V_{clamp}/V_{clamp}$ $\leq 10\%$
Mechanical Shock	MIL-STD-202, Method 213	Peak value 100g's Half sine Waveform Normal duration (D): 6ms In 3 directions perpendicularly intersecting each other (total 18 times)	No visible damage $\Delta V_{1mA}/V_{1mA}$ $\leq 10\%$ $\Delta V_{clamp}/V_{clamp}$ $\leq 10\%$
Thermal Shock	Specification Standard	Lower test temp. : -55 +0/-3°C Upper test temp. : 125 +3/-0°C Maximum transfer time: 20 seconds. Dwell time: 15 minutes. Air-Air. Number of cycles: 300	No visible damage $\Delta V_{1mA}/V_{1mA}$ $\leq 10\%$ $\Delta V_{clamp}/V_{clamp}$ $\leq 10\%$
Load Dump	ISO-7637	ISO 7637, test pulse 5 , load dump simulator, 10 pulses in with a one minute interval per pulse	$\Delta V_{1mA}/V_{1mA}$ $\leq 15\%$

Varistor: TVR-M Series

Dip Type Varistor for Automotive Application (Low Voltage Series)



Resistance to solvents	MIL-STD-202 Method 215	Add aqueous wash chemical- OKEM Clean or equivalent. Do not use banned solvents	No visible damage
------------------------	------------------------	---	-------------------

Package

Taping Specification

L Type (Straight Lead)

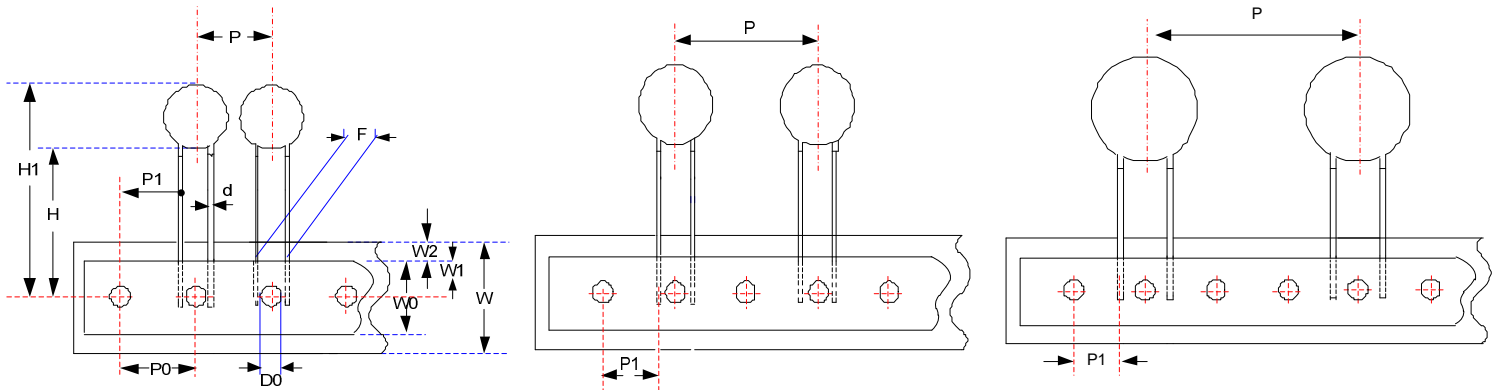

Figure A

Figure B

Figure C

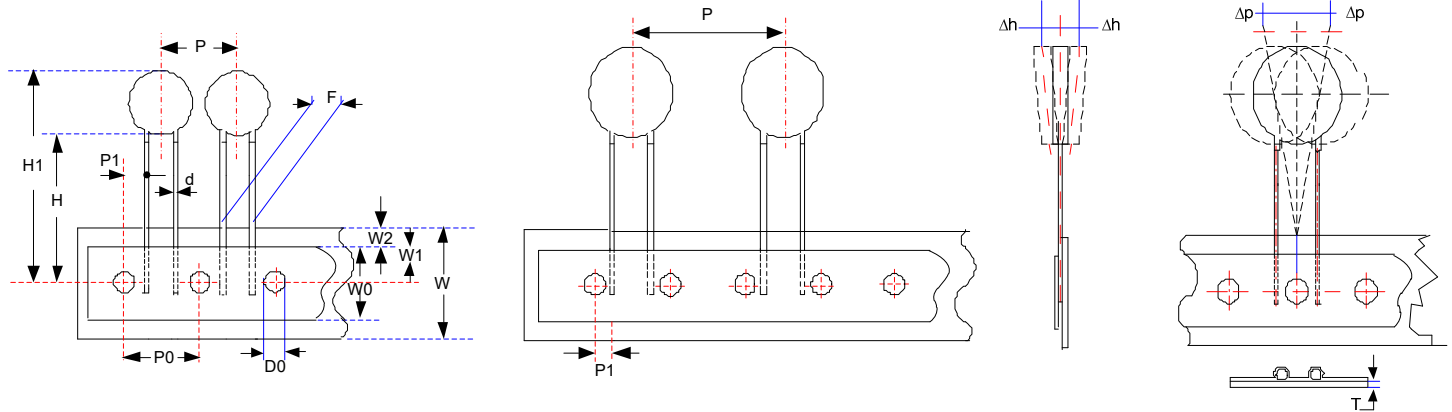

Figure D

Figure E

(Unit: mm)

Taping Code	Body Size	P ₀	F	P	P ₁	H	H ₁	d	W ₀	W ₁	W ₂	W	Δ P	Δ h	D ₀	T	Figure
		±0.3	±1	±1	±1	+2/-0	Max.	±0.02	±1	+0.75/-0.5	Max	+1/-0.5	Max.	Max.	±0.2	±0.2	
A (P ₀ :12.7)	07-M	12.7	5.0	12.7	3.55	18	31	0.6	12	9	3	18	1	2	4	0.6	D
	10-M	12.7	7.5	12.7	8.55	18	33.5	0.8	12	9	3	18	1	2	4	0.6	A
	14-M	12.7	7.5	25.4	8.55	18	38	0.8	12	9	3	18	1	2	4	0.6	B
	20-M	12.7	10.0	38.1	7.20	18	40.5	1.0	12	9	3	18	1	2	4	0.6	C
E (P ₀ :15.0)	07-M	15	5.0	15.0	4.70	18	31	0.6	12	9	3	18	1	2	4	0.6	D
	10-M	15	7.5	15.0	3.35	18	33.5	0.8	12	9	3	18	1	2	4	0.6	D
	14-M	15	7.5	30.0	3.35	18	38	0.8	12	9	3	18	1	2	4	0.6	E
	20-M	15	10.0	30.0	9.50	18	40.5	1.0	12	9	3	18	1	2	4	0.6	B

Varistor: TVR-M Series

Dip Type Varistor for Automotive Application (Low Voltage Series)



■ Quantity

● Bulk Packing

Series	Quantity of Straight Lead Type (pcs/bag)	Quantity of Cut Lead Type (pcs/bag)	Quantity of Kink Lead Type (pcs/bag)
TVR07(180~560)-M	250	250	200
TVR10(180~560)-M	200	200	200
TVR14(180~560)-M	100	100	100
TVR20(180~560)-M	Box Packing: 600 pcs	50	50

● Reel Packing

First Reel Packing

Series	A (mm)	Quantity (pcs/reel)
TVR07(180~560)-M	46	1,500
TVR10(180~560)-M	55	750
TVR14(180~470)-M		1,000
TVR14(560)-M		750
TVR20(180~560)-M		500

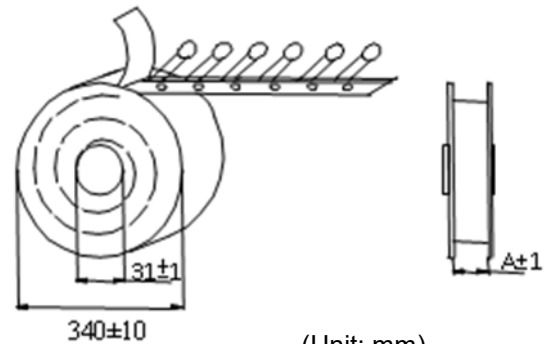

(Unit: mm)

Second Reel Packing

Series	A (mm)	Quantity (pcs/reel)	
		P0=12.7mm	P0=15mm
TVR07(180~560)-M	46	1,500	1,500
TVR10(180~560)-M		1,000	1,000
TVR14(180~470)-M		800	800
TVR14(560)-M		750	750
TVR20(180~560)-M	55	500	500

Varistor: TVR-M Series

Dip Type Varistor for Automotive Application (Low Voltage Series)



● Ammo Packing

Series	Quantity (pcs/box) P0=12.7mm	Quantity (pcs/box) P0=15.0mm
TVR07(180~560)-M	1,200	1,100
TVR10(180~560)-M	900	800
TVR14(180~560)-M	500	450
TVR20(180~560)-M	350	300

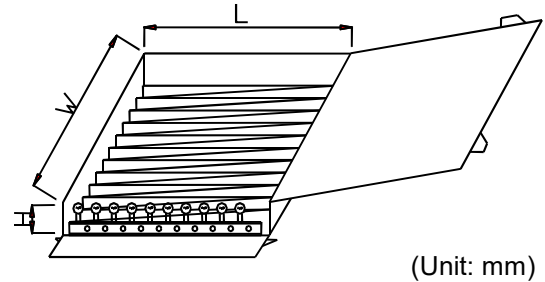

(Unit: mm)

Series	W±5	L±5	H±5
TVR05~TVR20-M	345	275	55

■ Warehouse Storage Conditions of Products

- Storage Conditions:
 1. Storage Temperature: $-10^{\circ}\text{C} \sim +40^{\circ}\text{C}$
 2. Relative Humidity: $\leq 75\% \text{RH}$
 3. Thermistors must be kept away from sunlight and stored in a non-corrosive atmosphere.
- Period of Storage: 1 year